

## THERMAL IMAGING CAMERAS



---

### *Thermal Imaging Cameras and systems designed for temperature measurement of dedicated industrial applications*

---

LumaSense thermal imaging cameras and systems accurately measure temperature and operate by using reliable infrared technology. These high-tech instruments can precisely determine the object temperature and the temperature distribution even on small and fast moving objects.

Thermal imaging cameras and systems perform an essential control function in major manufacturing industries. By monitoring the temperature, users can

control entire factory production processes as well as ensure highest quality standards.

Not only does LumaSense provide standard solutions, our thermal imaging instruments are flexible and capable of customer-specific adaptations to demands, special applications, and customer requirements. Due to our combination of highly skilled professionals and expert knowledge of the market, LumaSense can also provide exceptional customer support!

# Thermal Imaging Solutions

*LumaSense Technologies owns over 50 years of experience and has established an extensive customer base, enabling us to build up a complete product portfolio of thermal imaging systems tailored to the market and virtually meeting all needs of the industry.*

We realize the importance of providing solutions to industry partners and understand the significance of delivering reliable customer service that adds value. We developed a professional services organization which focuses on delivering consistent, sustainable world-class customer support. Our experts are ready to collaborate with our customers to deliver the right sensing solutions with the best performance and a long, reliable life.

We designed our new LumaServ™ program to support our customers so they get the most from their investment. In addition to our Basic Services which include factory repairs and calibrations, technical support, and a download center on our website, we offer the following additional services:

### Asset Assurance

- Extended Warranties
- Calibration Contracts
- Service Level Agreements
- Software Maintenance Agreements

### Field Services

- Project Engineering
- Project Management
- On-site Repair and Calibration
- Installation and Commissioning

### Training and Consulting System Level Services

- Tailored service packages including maintenance agreement

## Industrial Applications

### Steel Industry

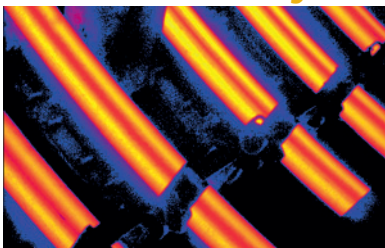

*Process monitoring steel production*

### Glass Industry

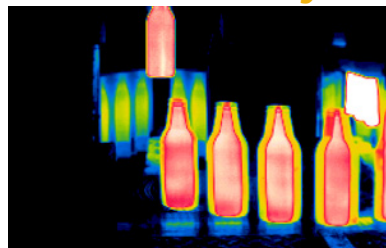

*Glass container and forms*

### Energy Efficiency

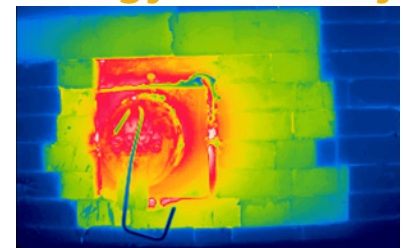

*Furnace maintenance*

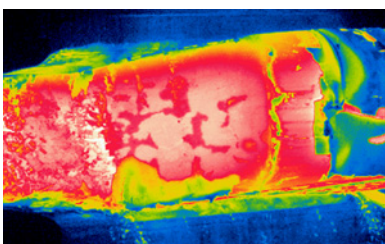

*Hot forming*

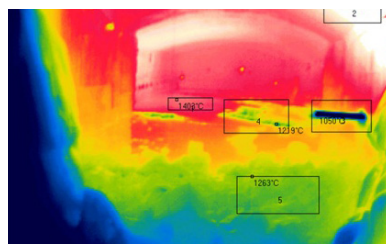

*Glass furnace*



*Combustion monitoring*

# Fixed Thermal Imaging Cameras

## LONG WAVE INFRARED

Model	MC320L	MC320LHT
Temperature Range	-40 to 120 °C, 0 to 500 °C	200 to 1600 °C
Resolution	320 x 240 pixels	320 x 240 pixels
Wavelength	8 to 14 $\mu\text{m}$	8 to 14 $\mu\text{m}$
Measuring Accuracy	$\pm 2$ °C or $\pm 2\%$ of reading	$\pm 2$ °C or $\pm 2\%$ of reading
NETD	0.06 °C	0.06 °C
Frame Frequency	60 Hz / 9 Hz (E)	60 Hz / 9 Hz (E)



## MID WAVE INFRARED

Model	MC320M/MHT	MC320F/FHT	MC320G/GHT
Temperature Range	M: 150 to 500 °C, 200 to 800 °C MHT: 400 to 1600 °C	F: 200 to 800 °C FHT: 600 to 1600 °C	G: 200 to 800 °C GHT: 600 to 1600 °C
Resolution	320 x 240 pixels	320 x 240 pixels	320 x 240 pixels
Wavelength	3 to 5 $\mu\text{m}$	3.9 $\mu\text{m}$	4.8 to 5.2 $\mu\text{m}$
Measuring Accuracy	$\pm 2$ °C or $\pm 2\%$ of reading	2 °C or $\pm 2\%$ of reading	2 °C or $\pm 2\%$ of reading
NETD	0.06 °C	0.06 °C	0.06 °C
Frame Frequency	60 Hz / 9 Hz (E)	60 Hz / 9 Hz (E)	60 Hz / 9 Hz (E)

## SHORT WAVE INFRARED

Model	MCS640	MCS640-HD
Temperature Range	600 to 3000 °C in up to 4 customer-specified ranges	600 to 3000 °C in up to 4 customer-specified ranges
Resolution	640 x 480 pixels	640 x 480 pixels
Wavelength	1 $\mu\text{m}$	1 $\mu\text{m}$
Measuring Accuracy	$\pm 0.5\%$ of reading in °K	$\pm 0.5\%$ of reading in °K
NETD	1 °C at 600 °C	1 °C at 600 °C
Frame Frequency	60 Hz	60 Hz



# Software

Windows-Based Thermal Imaging Software that Offers High-Speed Real-Time Data Acquisition and Image Analysis Capabilities

## LumaSpec™ RT

- Monitor Processes in Real-Time
- Eliminate or Reduce Downtime
- Lower Production Costs
- Save Time
- Increase Quality
- Reduce Safety Hazards

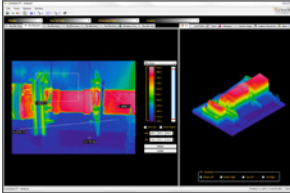

*LumaSpec RT Viewer*

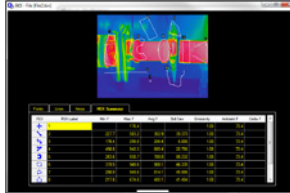

*LumaSpec RT Analyzer*

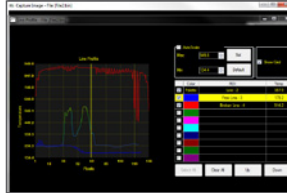

*LumaSpec RT Basic*

# System Configurations

## STANDALONE CONFIGURATION

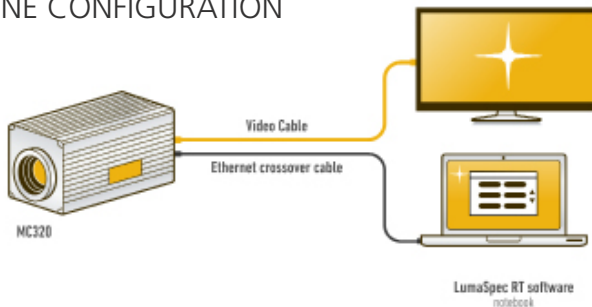

## MULTIPLE CAMERA SYSTEM

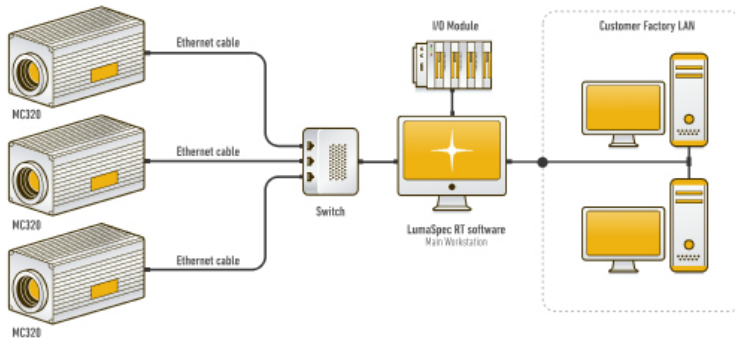

# Options & Enclosures



*ThermalSpection™ CVM*

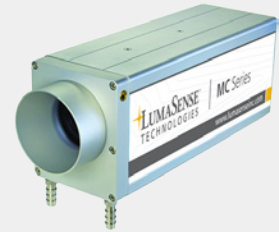

*ID-Vision*



*BoilerSpection™*



*Spyglass + lenses*



*ThermalSpection™ 724*

## LumaSense Technologies

## Temperature and Gas Sensing Solutions

Americas and Australia  
Sales & Service  
Santa Clara, CA  
Ph: +1 800 631 0176  
Fax: +1 408 727 1677

Europe, Middle East, Africa  
Sales & Service  
Frankfurt, Germany  
Ph: +49 69 97373 0  
Fax: +49 69 97373 167

India  
Sales & Support Center  
Mumbai, India  
Ph: +91 22 67419203  
Fax: +91 22 67419201

China  
Sales & Support Center  
Shanghai, China  
Ph: +86 133 1182 7766  
Fax: +86 21 5877 2383

[info@lumasenseinc.com](mailto:info@lumasenseinc.com)

LumaSense Technologies, Inc., reserves the right to change the information in this publication at any time.

[www.lumasenseinc.com](http://www.lumasenseinc.com)

© LumaSense Technologies. All rights reserved.  
ThermalImagingCamerasBrochure-EN Rev. 09/05/12