



INFRARED CAMERAS

The most versatile infrared cameras in the world

when temperature matters

The Compact- and the Precision Line offer imaging infrared temperature measuring devices for all applications

Advantages of the Xi Compact Line

- Motor focus
- Compact industrial imager for temperature measurements from -20 to $900\text{ }^{\circ}\text{C}$
- Autonomous operation with automatic spot finder and direct analog output – ideal for OEM use (Xi 80)
- Direct Ethernet interface (Xi 80)



Automatic hotspot search

Objects can be thermally analyzed and hot or cold spots can be found automatically.

Advantages of the PI Precision Line

- Interchangeable lenses
- Suited for fast processes (up to 1 kHz)
- High thermal sensitivity (up to 40 mK NETD)
- High optical resolution (up to 764 x 480 Pixel)
- Laser blocking filters
- Temperature measuring ranges from -20 to $2450\text{ }^{\circ}\text{C}$
- Different spectral ranges (500 nm 800 nm / $1\text{ }\mu\text{m}$ / $7.9\text{ }\mu\text{m}$ / $8 - 14\text{ }\mu\text{m}$)
- Delivered with test certificate

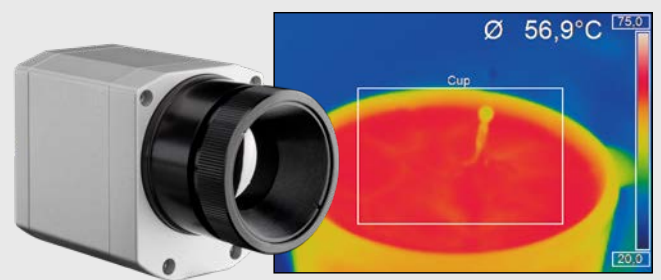

Fast measurements

Temperature distributions on a surface can be precisely recorded at millisecond intervals.

Autonomous operation with direct analog output

Up to 9 freely definable measuring areas may be used as analog outputs when using an external process interface.

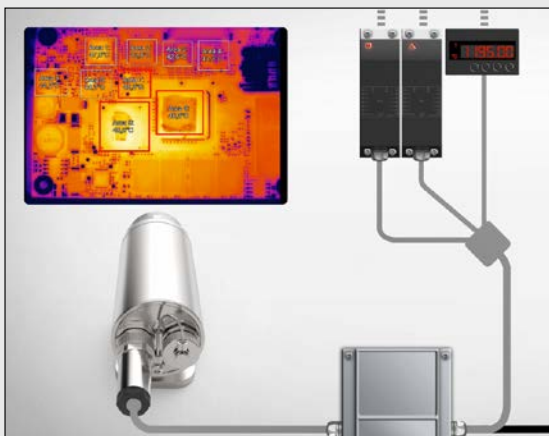

Simple process integration

Software Development Kit (SDK) for integration of the camera into customer-specific software via Dynamic Link Library (DLL) or COM-Port.

Interfaces to LabView and MATLAB are included as well.

optris Microscope optics

The interchangeable and focusable microscope optics enable electrical testing and thermal analysis of smallest components at the same time - with an optical resolution of up to $28\text{ }\mu\text{m}$. Fast processes can easily be monitored with a frame rate of up to 125 Hz and, with the recording of radiometric video sequences and images, be saved for later analysis.



Compact spot finder IR camera



- Industrial imager for precise temperature measurements from -20 to 900 °C
- Rugged, compact imager with motor focus
- Autonomous operation with automatic spot search and direct analog output
- 80 Hz frame rate for the monitoring of fast thermal processes
- Extensive ready-to-use package for an attractive price – incl. versatile image processing software and connection cables

Pyrometer or camera?

The Xi series is a fusion of a rugged, compact pyrometer and a modern IR camera.

Thanks to analog and digital outputs as well as the option to process up to nine freely definable measuring areas using an external process interface, the Xi camera is perfectly suited for OEM applications.



Integrated spot finder function

The integrated spot finder function allows for precise temperature measurements of moving objects - without having to readjust the sensor.

The camera figures it out on its own, without being connected to a PC.

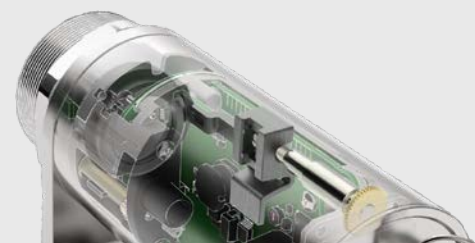
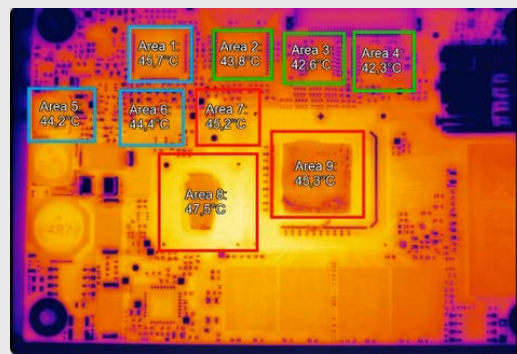

Motor focus simplifies handling

Both Xi models are equipped with a motorized focus.

The free PIX Connect software enables a remote focusing from the distance.

optris PI 400i

INFRARED CAMERA WITH HIGH OPTICAL RESOLUTION

One of the smallest camera in its class

- One of the smallest camera in its class (46 x 56 x 68 – 77 mm)
- Very good thermal sensitivity at 75 mK
- Thermal image recording up to 80 Hz
- Interchangeable lenses & industrial accessories
- Detector with 382 x 288 pixels
- Lightweight (237 – 251 g, depending on lens)
- Includes license-free analysis software and full SDK



High performance for a wide range of applications

The high-performance optris PI 400i infrared camera has a wide range of uses in industry.

For example, thermal image shots help to monitor processes and ensure the quality of manufactured products in the automotive field in particular, in the manufacturing of plastics as well as in the semiconductor and photovoltaic industry.

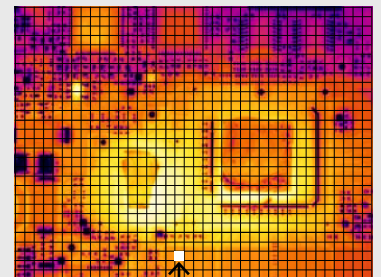

382 x 288 Pixel 10 x 10 Pixel = 40 mm²

SMD chip as measurement object:
measurement field size: 240 mm x 180 mm,
pixel size: 0.63 mm

80 Hz recordings with full pixel resolution

The display and recording of thermal images at full optical resolution can be done at high measurement speeds of 80 frames per second.

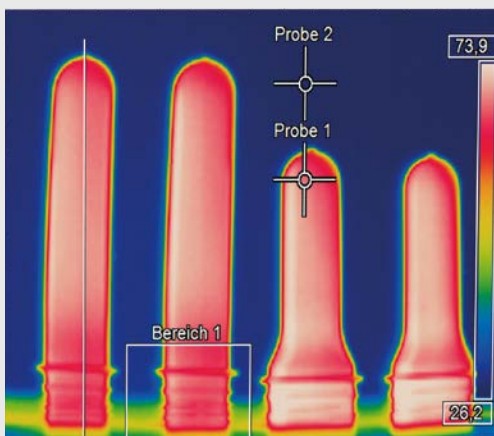

Thermal image shots of preforms in PET bottle production



Application examples, e.g. in the plastics industry:

www.optris.global/plastics

INFRARED CAMERA WITH VERY HIGH THERMAL SENSITIVITY

Detection of minimal temperature differences



- One of the smallest camera in its class (46 x 56 x 68 – 77 mm)
- Exceptional thermal sensitivity at 40 mK
- Thermal image recording up to 80 Hz
- Interchangeable lenses & industrial accessories
- Detector with 382 x 288 pixels
- Lightweight (237 – 251 g, depending on lens)
- Usable at ambient temperatures of up to 70 °C without the need for additional cooling
- Includes license-free analysis software and full SDK

Highest temperature resolution of 40 mK

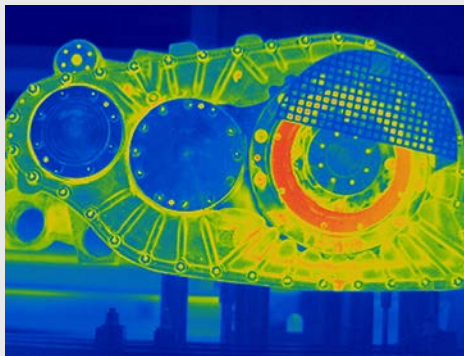

With an thermal resolution of 40 mK, the optris PI 450i is used for measuring the most subtle temperature differences, e.g. in the quality control of products or in preventive medicine.

Application example in the medical sector

Due to the very high resolution of the optris PI 450i, even veins can be made visible under the skin.

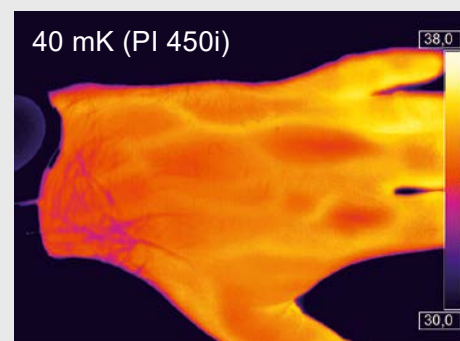
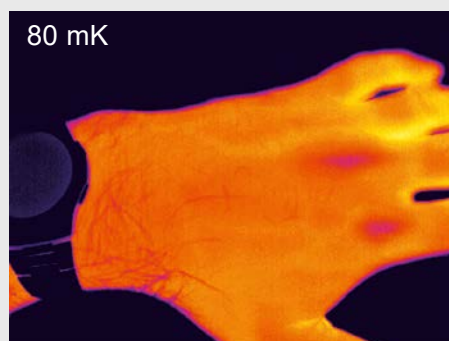

optris PI 640

THERMOGRAPHY IN VGA RESOLUTION

One of the most compact infrared camera in the world

- 640 x 480 pixels
- Radiometric video recording at 32 Hz / 125 Hz in subframe-mode (640 x 120 pixels)
- Compact size of 46 x 56 x 76 – 100 mm (depending on lens)
- Lightweight (269 – 340 g, depending on lens)
- Includes license-free analysis software and full SDK

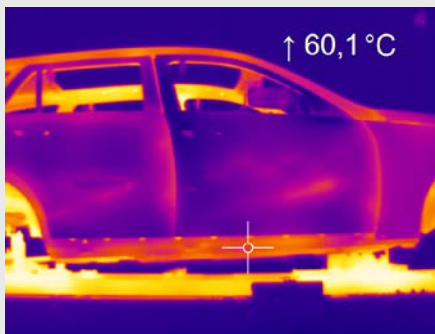
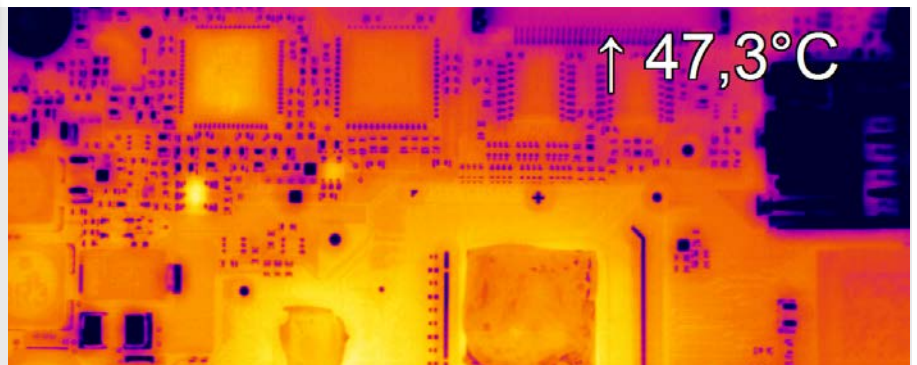
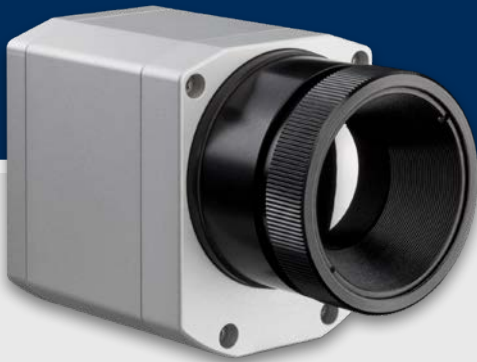

Razor sharp infrared pictures and videos for process optimization

With a casing size of only 46 x 56 x 90 mm and a weight of 320 grams (depending on lens), the optris PI 640 is among the most compact infrared cameras on the market.

The high-definition optris PI 640 infrared camera is best used in applications where finest thermal details matter.

It significantly contributes to process optimization in both research and development and in industry.

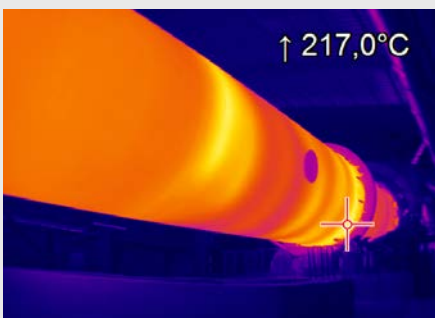

Application examples, e.g. the early detection of fires in garbage bunkers:

www.optris.global/fire-prevention

Microscope optics for the inspection of electronic boards

- Exchangeable, focusable optics for most flexible use of the camera
- Analysis of small chip level components down to 28 μm
- Hands-free operation for simultaneous testing and IR imaging
- Frame rates up to 125 Hz allow inspection of fast processes (like pulsed laser diodes)
- Radiometric video or tiff recording with ± 2 °C measurement accuracy
- License-free analysis software and complete SDK included

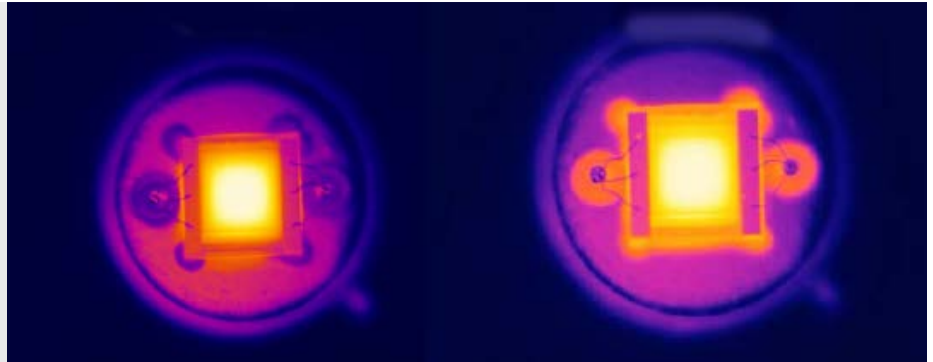

High resolution microscope optics for test & measurement

Besides the regular lenses, the PI 640 features a special microscope optics. Apart from detailed macro recordings of individual components, these also allow recordings of the entire circuit board.

High resolution macro shots of individual components are possible with a spatial resolution of 28 μm , the distance between the measurement object and camera is variable and can be adjusted between 80 and 100 mm.

The high-quality thermal and geometric detail resolution of the infrared cameras ensures precise functional testing of electronic products, as even the smallest temperature differences to be accurately detected.

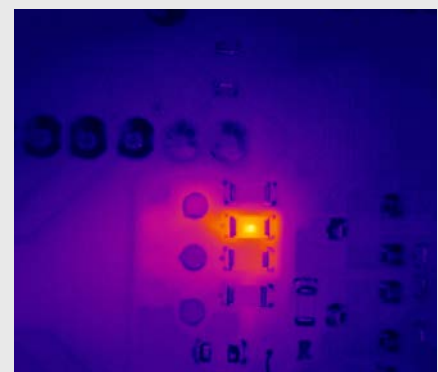
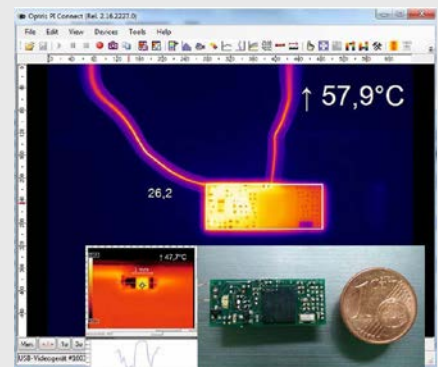

Recording of a circuit board with the optris PI 640



Application examples for the analysis of electronic boards:

www.optris.global/electronics-industry

optris PI 450i G7 / PI 640 G7

INFRARED CAMERAS FOR SURFACE TEMPERATURE MEASUREMENTS ON GLASS WITH LOW REFLECTIONS

High-resolution thermography for the glass industry

- Usable at ambient temperatures of up to 70 °C without the need for additional cooling
- With an integrated filter for the spectral range of 7.9 µm
- Compact size of 46 x 56 x 76 mm
- Frame rate up to 125 Hz
- Line scan function through license-free analysis software PIX Connect
- Max. scan angle of 111 °C with 800 pixels per line

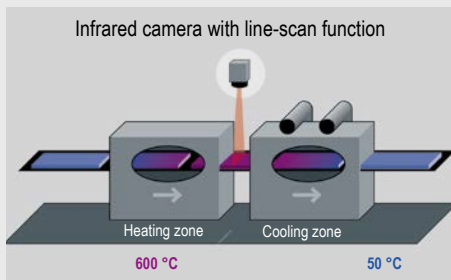

Construction of a glass tempering plant

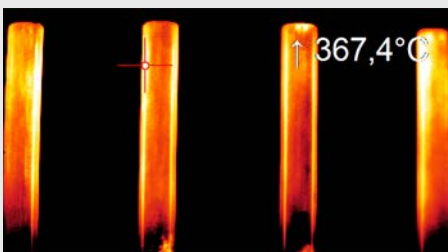

Glass tube manufacturing

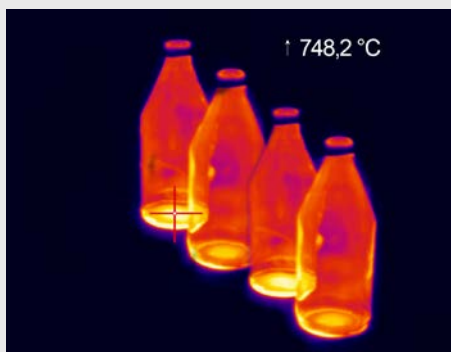

Hot-spot measurement in the production of glass bottles

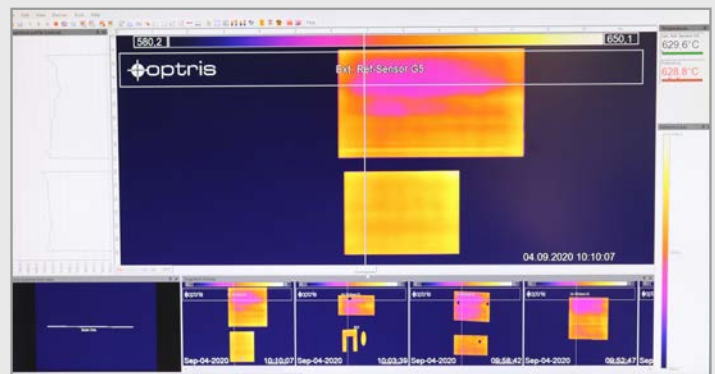

Glass panes between heating and cooling zone

Exact temperature measurements on glass surfaces via line-scan camera function

The temperature of glass is best measured in the range of spectral absorption bands.

For this purpose the optris PI 450i/ 640 G7 has an integrated 7.9 µm filter which enables an anechoic IR surface temperature measurement. Its compact size makes the optris PI 450i/ 640 G7 particularly suitable for use in confined spaces and for installation in industrial facilities. The infrared camera is fully operational at ambient temperatures of up to 70 °C without the need for cooling. With an imaging frequency of up to 125 Hz, glass products can be continuously tested, even in fast processing.

The line-scan camera function (line-scan mode) of the PIX Connect software enables the exact temperature measurement of panes of glass during transport on conveyor belts. This is a particularly important quality factor in tempering processes, e.g. in ESG and VSG.



Application examples for the glass industry:

www.optris.global/glass

Ultra compact infrared cameras for the metal industry

- Highly dynamic CMOS detector with an optical resolution of up to 764 x 480 pixels
- Very large temperature measurement ranges (without sub-ranges) of 450 °C to 1800 °C (PI 1M), 575 °C to 1900 °C (PI 08M) and of 900 °C to 2450 °C (PI 05M)
- Frame rates and linescanning function up to 1 kHz for fast processes
- Real-time output of 8x8 pixels with 1 ms response time
- Includes license-free analysis software and full SDK
- New: PI 08M - Ideally suited for all laser processing applications with solid-state lasers in NIR through excellent blocking of radiation



Smart temperature measurement – Innovative and fast

The IR cameras optris PI 05M, PI 08M and PI 1M are specially suited for measuring the temperature of metals, as these exhibit a distinctly higher emissivity at the short measurement wavelength of 500 nm and 1 µm than at measurements in the previously conventional wavelength range of 8 – 14 µm.

Especially the spectral range of 500 nm enables for more precise measurements at changing emissivities and is less sensitive to atmospheric influences. Thus, the PI 05M is ideally suited for temperature measurements of molten metals.

A direct 1 ms analog output allows all camera models a readout of a freely selectable 8x8 pixel region in real-time. The use of these image sensors allows a large dynamic range for temperature measurement so that the previously necessary use of relatively many and narrowly defined sub-ranges is no longer required. The PI 1M, PI 08M and PI 05M's two-dimensional temperature measurement opens up new options compared to the usual spot measurement of pyrometers.

Thanks to the large measurement temperature range of 450 up to 2450 °C, the optris PI 05M, PI 08M and PI 1M IR camera satisfies practically all demands in the fields of metal production and processing.

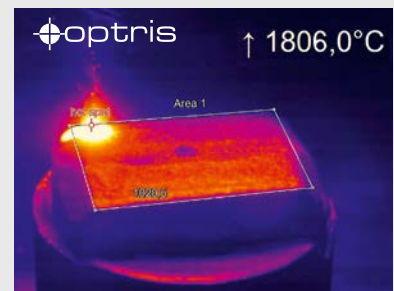

Measurement during laser welding process

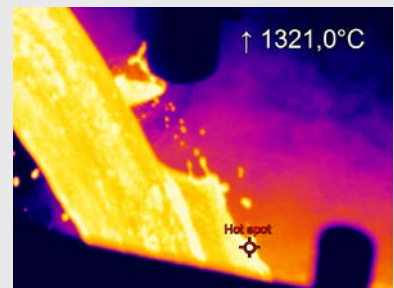

Measurement of a pouring stream

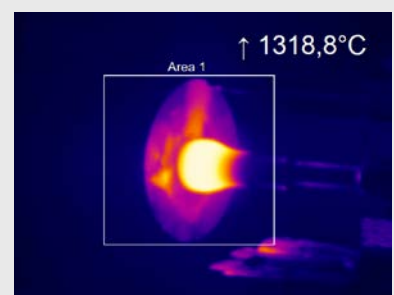

Electrical upsetting

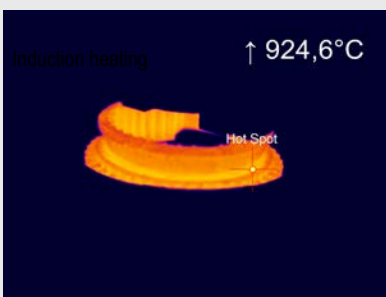

Induction heating



Application examples for the metal industry:

www.optris.global/metal

optris Xi infrared cameras – Compact Line

Optics calculator: www.optris.global/optics-calculator

Compact spot finder IR camera for use in harsh industrial environments, autonomous operation possible.



Basic model	Xi 80	Xi 400
Type	IR	IR
Detector	FPA, uncooled (34 μm pitch)	FPA, uncooled (17 μm pitch)
Optical resolution	80 x 80 pixels	382 x 288 pixels
Spectral range	8–14 μm	8–14 μm
Temperature ranges	–20 ... 100 °C 0 ... 250 °C (20) 150 ... 900 °C ¹⁾	–20 ... 100 °C 0 ... 250 °C (20) 150 ... 900 °C ¹⁾
Frame rate	50 Hz	80 Hz / 27 Hz
Optics (FOV)	30° (f = 5.1 mm) 12° (f = 12.7 mm) 55° (f = 3.1 mm) 80° (f = 2.3 mm)	29° x 22° (f = 12.7 mm) 18° x 14° (f = 20 mm) 53° x 38° (f = 7.7 mm) 80° x 54° (f = 5.7 mm)
New: Microscope optics	–	18° x 14° (f = 20 mm), smallest measuring spot: 90 μm (IFOV)
Focus	Manual motor focus	Manual motor focus
Optical resolution (D:S)	190:1 (12° optics)	390:1 (18° optics)
Thermal sensitivity (NETD)	100 mK	80 mK
System accuracy (at $T_{\text{Amb}} = 23 \pm 5$ °C)	± 2 °C or ± 2 %, whichever is greater	± 2 °C or ± 2 %, whichever is greater
PC interfaces	USB 2.0 / Ethernet (100 Mbit/s) / PoE	USB 2.0 / optional USB to GigE (PoE) interface
Direct in-/outputs / Standard process interface (PIF)	1x 0/4–20 mA output 1x input (analog or digital) Optically isolated	1x 0–10 V input 1x digital input (max. 24 V) 1x 0–10 V output
Industrial process interface (PIF)	3x analog outputs (0/4–20 mA or 0–10 V) or alarm OUT (relais) 3x inputs (analog or digital), fail-safe (LED and relay), stackable up to 3 PIFs; optically isolated	2 x 0–10 V inputs, 1 x digital input (max. 24 V), 3x 0/4-20 mA outputs, 3 x relay (0–30 V / 400 mA), faile-safe relay
Cable length (USB)	USB: 1 m (standard), 3 m, 5 m, 10 m and 20 m Ethernet / RS485: 100 m	USB: 1 m (standard), 3 m, 5 m, 10 m and 20 m
Ambient temperature (T_{Amb})	0 °C ... 50 °C	0 °C ... 50 °C
Size / class	\varnothing 36 x 90 mm (M30x1 thread) / IP 67 (NEMA 4)	\varnothing 36 x 100 mm (M30x1 thread) / IP 67 (NEMA 4)
Weight (without mounting bracket)	201 - 210 g (depending on lens)	216 - 220 g (depending on lens)
Shock / Vibration ²⁾	IEC 60068-2	IEC 60068-2
Power supply	USB / PoE / 5-30 VDC	via USB
Scope of supply (standard)	<ul style="list-style-type: none"> • Xi camera • USB cable (1 m) • Cable for in-/outputs (1 m) with terminal block • Mounting bracket with tripod thread, mounting nut • Software package optris PIX Connect • Quick start guide 	<ul style="list-style-type: none"> • Xi camera • USB cable (1 m) • Cable for in-/outputs (1 m) with terminal block • Mounting bracket with tripod thread, mounting nut • Software package optris PIX Connect • Quick start guide



Microscope optics for the inspection of assembled circuit boards

The new microscope optics for the **optris Xi 400** infrared camera allows reliable temperature measurement on tiny objects from **240 μm (MFOV)**. In combination with a suitable stand, this enables professional measurement of printed circuit boards and components in the electronics industry. The measuring distance between camera and object is variable between 90 and 110 mm. Due to the built-in motor focus, the camera can be easily mounted in the supplied PIX Connect software focus. For measuring even smaller objects we recommend the PI 640 microscope optics, **smallest measuring spot: 28 μm (IFOV)**.

Further information on page 12.

www.optris.global/optris-xi-400-microscope-optics

¹⁾ Accuracy effective starting at 150 °C

²⁾ For further details see operator's manual

EXPANSION OPTIONS



Air purge unit

Features:

- The air purge attachment can be used in combination with the water cooled housing and protects the optics from contamination
- Used in rough and dusty areas to guarantee a reliable temperature measurement

Part number: **ACXIAPL + ACXIAPLAB**
(Mounting bracket)



Water cooled housing

Features:

- The rugged water cooled housing allows the Xi infrared cameras to be employed in hot environments up to 250°C
- Respective heat-resistant cables are also available

Part number: **ACXIW**



Shutter

Features:

- In addition Xi cameras can be equipped with a shutter
- The shutter protects the optics from falling parts within a response time of 100 ms

Part number: **ACXISCBxx***

*xx = for different cable lengths



Outdoor protective housing for Xi series

Features:

- Environmental rating IP 66
- Additional air purge collar allows continuous operation in dusty and humid environments
- Heating element and built-in fan enable for a 24/7 operation from -40 °C to 50 °C
- Installation of USB Server Gigabit 2.0 and industrial process interface possible for integration into control systems over large outdoor distances

Part number: **ACXIOPH24**



USB server Gigabit 2.0 for Xi 400

Features:

- Fully USB 2.0 compatible, Data rates: 1.5 / 12 / 480 mbps, USB transfer mode: Isochronous
- Network connection via Gigabit Ethernet
- Full TCP/IP support incl. routing and DNS
- Two independent USB ports
- Supply from PoE or external power supply with 24 – 48 V DC
- Galvanic isolation 500 V_{RMS} (network connection)
- Remotely configurable via Web Based Management
- Proven technology from Wiesemann & Theis

Part number: **ACPIUSBSGB**

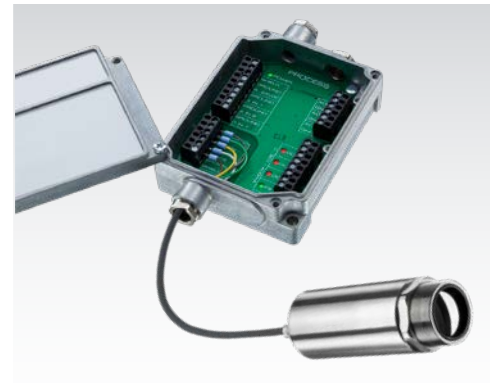

Industrial process interface (PIF) for Xi series

Features:

- Industrial process interface for Xi 400 with 3 analog/alarm outputs, 2 analog inputs, 1 digital input, 3 alarm relays
- Industrial process interface for Xi 80 with 3 analog-/alarm outputs, 3 inputs (analog or digital), 3 alarm relays
- 500 VAC_{RMS} isolation voltage between camera and process
- Separate fail-safe relay output
- Xi hardware including all cable connections and PIX Connect software are permanently observed during operation
- Option Xi 80: stackable up to 3 PIFs

Part number: **Xi 80: ACXIPIFCBx***
Part number: **Xi 400: ACPIPIFMACBx***

x* = for different cable lengths

optris PI infrared cameras - Precision Line

Optics calculator: www.optris.global/optics-calculator

Compact infrared cameras with high resolution for fast online applications and exchangeable lenses, including line scan function



Basic model		PI 400i / PI 450i	PI 640	PI 640 Microscope optics
Type		IR	IR	IR
Detector		FPA, uncooled (17 µm pitch)	FPA, uncooled (17 µm pitch)	FPA, uncooled (17 µm pitch)
Optical resolution		382 x 288 pixels	640 x 480 pixels VGA 640 x 120 pixels @ 125 Hz	640 x 480 pixels @ 32 Hz 640 x 120 pixels @ 125 Hz
Spectral range		8 – 14 µm	8 – 14 µm	8 – 14 µm
Temperature ranges		-20 ... 100 °C 0 ... 250 °C, (20) 150 ... 900 °C ¹⁾ 200 ... 1500 °C (option)	-20 ... 100 °C 0 ... 250 °C (20) 150 ... 900 °C ¹⁾ 200 ... 1500 °C (option)	-20 ... 100 °C 0 ... 250 °C (20) 150 ... 900 °C ¹⁾ 200 ... 1500 °C (option)
Frame rate		80 Hz / switchable to 27 Hz	32 Hz / 125 Hz in subframe mode (640x120 pixels)	32 Hz / 125 Hz in subframe mode (640 x 120 pixels)
Optics (FOV)		29° x 22° / f = 12.7 mm or 18° x 14° / f = 20 mm or 53° x 38° / f = 7.7 mm or 80° x 54° / f = 5.7 mm	33° x 25° / f = 18.7 mm or 15° x 11° / f = 41.5 mm or 60° x 45° / f = 10.5 mm or 90° x 64° / f = 7.7 mm	12° x 9° (F=1.1) / f = 44 mm Smallest measuring spot: 28 µm
Thermal sensitivity (NETD)		PI 400i: 75 mK with 29°, 53°, 80° FOV PI 450i: 40 mK with 29°, 53°, 80° FOV optics mentioned above: F = 0.9 PI 400i: 0.1 K with 18° FOV / F = 1.1 PI 450i: 60 mK with 18° FOV / F = 1.1	75 mK	120 mK
System accuracy (at T _{Amb} = 23 ± 5 °C)		±2 °C or ±2 %, whichever is greater	±2 °C or ±2 %, whichever is greater	±2 °C or ±2 %, whichever is greater
Temperature coefficient		±0,05 % / K ²⁾	±0,05 % / K ²⁾	±0,05 % / K ²⁾
PC interfaces		USB 2.0 / optional USB to GigE (PoE) Interface	USB 2.0 / optional USB to GigE (PoE) Interface	USB 2.0 / optional USB to GigE (PoE) Interface
Process interface (PIF)	Standard PIF	1x 0–10 V input, 1x digital input (max. 24 V), 1x 0–10 V output	1x 0–10 V input, 1x digital input (max. 24 V), 1x 0–10 V output	1x 0–10 V input, 1x digital input (max. 24 V), 1x 0–10 V output
	Industrial PIF (optional)	2x 0–10 V input, 1x digital input (max. 24 V), 3x 0/4–20 mA output, 3x relays (0–30 V / 400 mA), 1x fail-safe-relay	2x 0–10 V input, 1x digital input (max. 24 V), 3x 0/4–20 mA output, 3x relays (0–30 V / 400 mA), 1x fail-safe-relay	2x 0–10 V input, 1x digital input (max. 24 V), 3x 0/4–20 mA output, 3x relays (0–30 V / 400 mA), 1x fail-safe-relay
Ambient temperature (T _{Amb})		PI 400i: 0 ... 50 °C / PI 450i: 0 ... 70 °C	0 ... 50 °C	0 ... 50 °C
Storage temperature		PI 400i: -40... 70 °C PI 450i: -40 ... 85 °C	-40 ... 70 °C	-40 ... 70 °C
Relative Humidity		10–95 %, non-condensing	10–95 %, non-condensing	10–95 %, non-condensing
Size / class		46 x 56 x 68 – 77 mm (depending on lens and focus position)/ IP 67 (NEMA 4)	46 x 56 x 76 - 100 mm (depending on lens and focus position)/ IP 67 (NEMA 4)	46 x 56 x 119 - 126 mm (depending on lens and focus position)/ IP 67 (NEMA 4)
Weight		237 - 251 g, depending on lens	269 - 340 g, depending on lens	370 g, incl. lens
Shock / Vibration ³⁾		IEC 60068-2	IEC 60068-2	IEC 60068-2
Tripod mount		1/4 - 20 UNC	1/4 - 20 UNC	1/4 - 20 UNC
Power supply		via USB	via USB	via USB
Scope of supply (standard)		<ul style="list-style-type: none"> • USB camera with 1 lens • USB cable (1 m) • Table tripod • PIF cable with terminal block (1 m) • Manual • Aluminum case (PI 400i) • Rugged outdoor case (PI 450i) • Software package optris PIX Connect 	<ul style="list-style-type: none"> • USB camera with 1 lens • USB cable (1 m) • Table tripod • PIF cable with terminal block (1 m) • Manual • Rugged outdoor case • Software package optris PIX Connect 	<ul style="list-style-type: none"> • USB camera with lens kit (standard lens [PI 640: O33], microscope lens [MO44]) • Microscope stand • Standard USB cable (1 m) • Standard-PIF • Manual • Rugged outdoor case • Software package optris PIX Connect

¹⁾ Accuracy effective starting at 150 °C

²⁾ For T_{Amb} 10...50 °C and T_{Obj} ≤ 500 °C; otherwise: ± 0,1 K/K or 0,1%/K (whichever is greater)

³⁾ For further details see operator's manual



PI 450i G7	PI 640 G7
IR	IR
FPA, uncooled (17 µm pitch)	FPA, uncooled (17 µm pitch)
382 x 288 pixels	640 x 480 pixels
7.9 µm	7.9 µm
150 ... 900 °C 200 ... 1500 °C	150 ... 900 °C 200 ... 1500 °C
80 Hz / switchable to 27 Hz	32 Hz / 125 Hz in subframe mode (640x120 pixels)
29° x 22° / f = 12.7 mm or 18° x 14° / f = 20 mm or 53° x 38° / f = 7.7 mm or 80° x 54° / f = 5.7 mm	33° x 25° / f = 18.7 mm or 15° x 11° / f = 42 mm or 60° x 45° / f = 10.5 mm or 90° x 64° / f = 7.7 mm
150 mK 175 mK (with 18 ° FOV)	130 mK 150 mK (with 15 ° FOV)
±2 °C or ±2 %, whichever is greater	±2 °C or ±2 %, whichever is greater
-	-
USB 2.0 / optional USB to GigE (PoE) Interface	USB 2.0 / optional USB to GigE (PoE) Interface
1x 0–10 V input, 1x digital input (max. 24 V), 1x 0–10 V output	1x 0–10 V input, 1x digital input (max. 24 V), 1x 0–10 V output
2x 0–10 V input, 1x digital input (max. 24 V), 3x 0/4–20 mA output, 3x relays (0–30 V / 400 mA), 1x fail-safe-relay	2x 0–10 V input, 1x digital input (max. 24 V), 3x 0/4–20 mA output, 3x relays (0–30 V / 400 mA), 1x fail-safe-relay
0 ... 70 °C	0 ... 50 °C
–40 ... 85 °C	–40 ... 70 °C
10–95 %, non-condensing	10–95 %, non-condensing
46 x 56 x 68 – 77 mm (depending on lens and focus position)/ IP 67 (NEMA 4)	46 x 56 x 76 – 100 mm (depending on lens and focus position)/ IP 67 (NEMA 4)
237 - 251 g, depending on lens	269 - 340 g, depending on lens
IEC 60068-2	IEC 60068-2
1/4 - 20 UNC	1/4 - 20 UNC
via USB	via USB
<ul style="list-style-type: none"> • USB camera with 1 lens • USB cable (1 m) • Table tripod • PIF cable with terminal block (1 m) • Manual • Rugged outdoor case • Software package optris PIX Connect 	<ul style="list-style-type: none"> • USB camera with 1 lens • USB cable (1 m) • Table tripod • PIF cable with terminal block (1 m) • Manual • Rugged outdoor case • Software package optris PIX Connect

optris PI infrared cameras - Precision Line

Optics calculator: www.optris.global/optics-calculator

Compact infrared cameras with high resolution for fast online applications and exchangeable lenses, including line scan function



Basic model		PI 05M		PI 08M		PI 1M	
Type		IR		IR		IR	
Detector		CMOS (15 µm pitch)		CMOS (15 µm pitch)		CMOS (15 µm pitch)	
Optical resolution		764 x 480 pixels @ 32 Hz 382 x 288 pixels @ 80 Hz (switchable to 27 Hz) 72 x 56 pixels @ 1 kHz 764 x 8 pixels @ 1 kHz (fast line scan mode)		764 x 480 pixels @ 32 Hz 382 x 288 pixels @ 80 Hz (switchable to 27 Hz) 72 x 56 pixels @ 1 kHz 764 x 8 pixels @ 1 kHz (fast line scan mode)		764 x 480 pixels @ 32 Hz 382 x 288 pixels @ 80 Hz (switchable to 27 Hz) 72 x 56 pixels @ 1 kHz 764 x 8 pixels @ 1 kHz (fast line scan mode)	
Spectral range		500 – 540 nm		780 – 820 nm		0.85 – 1.1 µm	
Temperature range		900 ... 2450 °C (27 Hz mode) 950 ... 2450 °C (32 / 80 Hz mode) 1100 ... 2450 °C (1 kHz mode)		575 ... 1900 °C (27 Hz mode) 625 ... 1900 °C (32 / 80 Hz mode) 750 ... 1900 °C (1 kHz mode)		450 ¹⁾ ... 1800 °C (27 Hz mode) 500 ¹⁾ ... 1800 °C (80 Hz and 32 Hz mode) 600 ¹⁾ ... 1800 °C (1 kHz mode)	
Frame rate		Up to 1 kHz / 1 ms real time analog output (0 - 10 V) of 8 x 8 pixels (freely selectable)		Up to 1 kHz / 1 ms real time analog output (0 - 10 V) of 8 x 8 pixels (freely selectable)		Up to 1 kHz / 1 ms real time analog output (0 - 10 V) of 8 x 8 pixels (freely selectable)	
Optics (FOV)		FOV@ 764 x 480 px: 26° x 16° (f=25 mm)	FOV@ 382 x 288 px: 13° x 10° (f=25 mm)	FOV@ 764 x 480 px: 39° x 25° (f=16 mm) 26° x 16° (f=25 mm)	FOV@ 382 x 288 px: 20° x 15° (f=16 mm) 13° x 10° (f=25 mm)	FOV@ 764 x 480 px: 39° x 25° (f=16 mm) 26° x 16° (f=25 mm) 13° x 8° (f=50 mm) 9° x 5° (f=75 mm)	FOV@ 382 x 288 px: 20° x 15° (f=16 mm) 13° x 10° (f=25 mm) 7° x 5° (f=50 mm) 4° x 3° (f=75 mm)
Thermal sensitivity NETD ²⁾		< 2 K (< 1400 °C) < 4 K (< 2100 °C)		< 2 K (< 1000 °C) < 4 K (< 1600 °C)		< 2 K (< 900 °C) < 4 K (< 1400 °C)	
System accuracy (at T _{Amb} = 23 ±5 °C)		For object temperature < 2000 °C: ±1 % of reading for 27/32/80 Hz ±1,5 % of reading for 1 kHz For object temperature > 2000 °C: ±2 % of reading for 27/32/80 Hz ±2,5 % of reading for 1 kHz		For object temperature < 1500 °C: ±1 % of reading for 27/32/80 Hz ±1,5 % of reading for 1 kHz For object temperature > 1500 °C: ±2 % of reading for 27/32/80 Hz ±2,5 % of reading for 1 kHz		For object temperature < 1400 °C: ±1 % of reading for 27/32/80 Hz ±1,5 % of reading for 1 kHz For object temperature < 1600 °C: ±2 % of reading for 27/32/80 Hz ±2,5 % of reading for 1 kHz	
PC interfaces		USB 2.0 / optional USB zu GigE (PoE) Interface		USB 2.0 / optional USB zu GigE (PoE) Interface		USB 2.0 / optional USB zu GigE (PoE) Interface	
Process Interface (PIF)	Standard PIF	1x 0 – 10 V input, 1x digital input (max. 24 V), 1x 0 – 10 V output		1x 0 – 10 V input, 1x digital input (max. 24 V), 1x 0 – 10 V output		1x 0 – 10 V input, 1x digital input (max. 24 V), 1x 0 – 10 V output	
	Industrial PIF (optional)	2x 0 – 10 V inputs, 1x digital input (max. 24 V), 3x 0/4-20 mA outputs, 3x relays (0 – 30 V / 400 mA), 1x fail-safe relay		2x 0 – 10 V inputs, 1x digital input (max. 24 V), 3x 0/4 – 20 mA outputs, 3x relays (0 – 30 V / 400 mA), 1x fail-safe relays		2x 0 – 10 V inputs, 1x digital input (max. 24 V), 3x 0/4-20 mA outputs, 3x relays (0 – 30 V / 400 mA), 1x fail-safe relays	
Ambient temperature (T _{Amb})		5 ... 50 °C		5 ... 50 °C		5 ... 50 °C	
Storage temperature		– 40 ... 70 °C		– 40 ... 70 °C		– 40 ... 70 °C	
Relative Humidity		10 – 95 %, non-condensing		10 – 95 %, non-condensing		10 – 95 %, non-condensing	
Size / class		46 x 56 x 88 – 129 mm with protection tube (depending on lens and focus position) / IP 67 (NEMA 4)		46 x 56 x 88 – 129 mm with protection tube (depending on lens and focus position) / IP 67 (NEMA 4)		46 x 56 x 88 – 129 mm with protection tube (depending on lens and focus position) / IP 67 (NEMA 4)	
Weight		245 - 311 g, depending on lens		245 - 311 g, depending on lens		245 - 311 g, depending on lens	
Shock / Vibration ⁴⁾		IEC 60068-2		IEC 60068-2		IEC 60068-2	
Tripod mount		1/4- 20 UNC		1/4- 20 UNC		1/4- 20 UNC	
Power supply		via USB		via USB		via USB	
Scope of supply (standard)		<ul style="list-style-type: none"> • USB camera with 1 lens • Lens tube incl. protective window • USB cable (1 m) • Table tripod • PIF cable with terminal block (1 m) • Software package optris PIX Connect • Manual • Aluminum case • Optional: CoolingJacket, HT cable 		<ul style="list-style-type: none"> • USB camera with 1 lens • Lens tube incl. protective window • USB cable (1 m) • Table tripod • PIF cable with terminal block (1 m) • Manual • Software package optris PIX Connect • Aluminum case • Optional: CoolingJacket, HT cable 		<ul style="list-style-type: none"> • USB camera with 1 lens • Lens tube incl. protective window • USB cable (1 m) • Table tripod • PIF cable with terminal block (1 m) • Manual • Software package optris PIX Connect • Aluminum case • Optional: CoolingJacket, HT cable 	

¹⁾ Accuracy effective starting at +75 °C with optics (f = 50 mm and f = 75 mm) ²⁾ Specified NETD value applies to all frequencies ³⁾ At an ambient temperature of +25 °C ⁴⁾ For further details see operator's manual

UNIVERSAL PROTECTIVE HOUSING FOR COOLING UP TO 315 °C

Universal protection for the optris PI series in harsh industrial environments

- Operation at ambient temperatures of up to 315 °C
- Air/Water cooling with integrated air purging and optional protective windows
- Modular design for easy fitting of different devices and lenses
- Trouble-free, on the spot sensor removal via quick-release chassis
- Integration of additional components like PI NetBox, USB Server Gigabit and Industrial Process Interface (PIF) in the extended version



Technical data	CoolingJacket Advanced Standard	CoolingJacket Advanced Extended
Protective rating	IP 65	IP 65
Ambient temperature	Up to 315 °C ¹⁾	Up to 315 °C ¹⁾
Relative Humidity	10 - 95 %, non-condensing	10 - 95 %, non-condensing
Material (Housing)	V2A	V2A
Dimensions	271 x 166 x 182 mm	426 x 166 x 182 mm
Weight	5.7 kg	7.8 kg
Air purge collar	G1/4" internal thread G3/8" external thread	G1/4" internal thread G3/8" external thread
Cooling water fittings	G1/4" internal thread G3/8" external thread	G1/4" internal thread G3/8" external thread
Cooling water pressure	max. 15 bar (217 psi)	max. 15 bar (217 psi)
Scope of supply	<ul style="list-style-type: none"> • CoolingJacket Advanced, consisting of housing with mounting brackets, chassis and focusing unit respectively front part²⁾ • Installation instructions 	<ul style="list-style-type: none"> • CoolingJacket Advanced, consisting of housing with mounting brackets, chassis and focusing unit respectively front part²⁾ • Mounting accessories for - PI Netbox or USB-Server Gigabit 2.0 - Industrial PIF • Installation instruction

¹⁾ Cable for up to 250 °C ambient temperature as well as cable cooling for up to 315 °C available.

²⁾ Focusing unit and front part are exchangeable and have to be ordered separately.

Dimensions in mm

CoolingJacket Advanced – Standard-Version

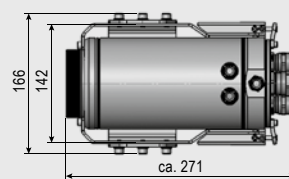

CoolingJacket Advanced – Extended-Version

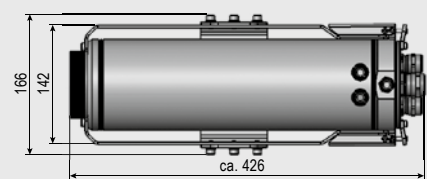

optris Laminar air purge

AIR PURGE FOR RUGGED ENVIRONMENTS

Laminar air purge for rugged environments

- Protection for rugged environments
- Air and water cooling, flexible laminar air stream for protection from dirt and dust
- Easy maintenance due to folding mechanism
- Focussable from the outside once installed
- Protection window for mechanical protection integrated
- Also available as line scanner version



Technical data

Protective rating	IP 65
Ambient temperature	Up to 315 °C (with water cooling)
Material	Aluminum
Dimensions (B x H x T)	200 x 189 x 43 mm
Weight	1.9 kg
Air purge connection	NW 7.2
Cooling water connection	G3/8" external thread
Cooling water pressure	Max. 8 bar
Volume flow	40 - 120 l/min
Air pressure	1.1 - 8 bar
Protective window	Necessary ¹⁾
Version / Options	Also available as line scan option

¹⁾ A protective window (67 x 3 mm) has to be ordered separately.

Dimensions in mm

Laminar air purge: standard model

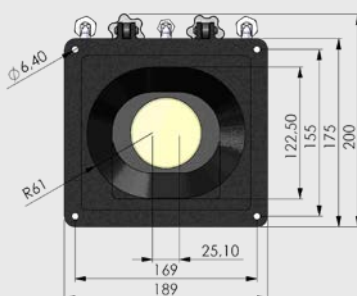

Laminar air purge: line scan model

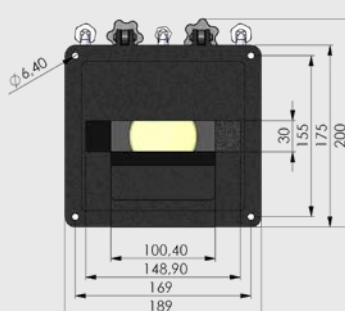

Laminar air purge: connections

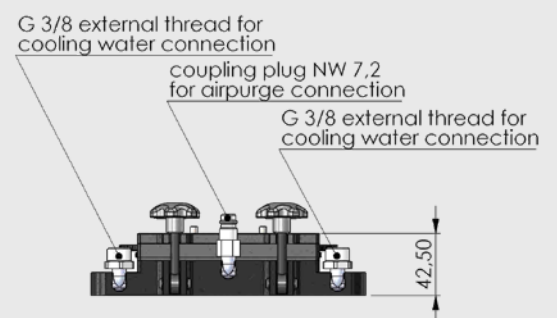

Camera and process control for use in industrial environment

- Industrial Process Interface for **PI series and Xi 400** with 3 analog-/alarm outputs, 2 analog inputs, 1 digital input, 3 alarm relays
- Industrial Process Interface for **Xi 80** with 3 analog-/alarm outputs, 3 inputs (analog or digital), 3 alarm relays
- 500 V AC_{RMS} isolation voltage between camera and process
- Separate fail-safe relay output
- The PI / Xi hardware with all cable connections and the PIX Connect software are permanently monitored during operation
- Combination of up to 3 PIFs when using the Xi 80



General specifications

Protective rating	IP65 (NEMA-4)
Ambient temperature	-30 °C ... 85 °C
Storage temperature	-30 °C ... 85 °C
Humidity	10–95 % (non-condensing)
Vibrational stability	IEC 60068-2-6 (non-condensing)/ IEC 60068-2-64 (broadband noise)
Shock stability	IEC 60068-2-27 (25 G and 50 G)
Weight	610 g (with 5 m HT cable)
Cable lengths	5 m HT cable (standard), optional 10 m and 20 m

Electrical specifications

	Xi 80	PI series and Xi 400
Power supply	5–24 V DC	5–24 V DC
LED display	2 green LEDs for voltage and fail-safe / 3 red LEDs for status of alarm relays	2 green LEDs for voltage and fail-safe / 3 red LEDs for status of alarm relays
Isolation	500 V AC _{RMS} between camera and process	500 V AC _{RMS} between camera and process
Outputs	3 analog-/ alarm outputs / 3 alarm relays	3 analog-/ alarm outputs / 3 alarm relays ¹
Inputs	3 inputs (analog or digital)	2 analog inputs / 1 digital input
Ranges	0/4–20 mA or 0–10 V (for AO 1–3) ² , 0–10 V or 24 V (for inputs 1–3), 0–30 V/400 mA (for alarm relays DO 1–3)	0/4–20 mA (for AO 1–3) ² , 0–30 V / 400 mA (for alarm relays DO1–3), 0–10 V (for AI 1–2) / 24 V (for DI)

Programmable functions

Analog inputs	<ul style="list-style-type: none"> • Emissivity settings • Reference temperature • Triggered snapshots, triggered recordings, triggered line scan camera, triggered event grabber 	<ul style="list-style-type: none"> • Ambient temperature compensation • Uncommitted value • Flag control • Reset peak-/valley hold
Digital inputs	<ul style="list-style-type: none"> • Flag control • Triggered snapshots, triggered recordings, triggered line scan camera, triggered event grabber 	<ul style="list-style-type: none"> • Reset peak-/valley hold
Analog outputs	<ul style="list-style-type: none"> • Main measurement range • Measurement range • Internal temperature • Flag status 	<ul style="list-style-type: none"> • Alarm • Frame synchronisation • Fail-safe • External communication

¹ Active when AO1, 2 or 3 is / are programmed as alarm output

² Dependent on supply voltage

optris PI NetBox

MINI PC FOR OPTRIS PI SERIES

Stand alone solution for optris PI series

- Miniatur PC as an add-on to the PI series for stand-alone system of for cable extension via GigE
- Integrated hardware and software watchdog
- Installation of additional user software possible
- Status LEDs
- Processor: Intel Atom® E3940 Quad Core 1.6 / 1.8 GHz (Turbo), 32 GB SSD, 4 GB RAM
- Connections: 2x USB 2.0, 1x USB 3.0, 1x Mini USB 2.0, Micro HDMI, Ethernet (Gigabit Ethernet), Micro SDHC / SDXC card
- Operating system: Windows 10 Enterprise
- Wide supply voltage range (8 – 48 VDC) or Power over Ethernet (PoE)
- Can be integrated with CoolingJacket Advanced



General specifications

Ambient temperature	0 °C... 50 °C
Storage temperature	-20 °C... 75 °C
Relative Humidity	10-95 %, non-condensing
Material (Housing)	Anodized aluminum
Size	113 x 57 x 47 mm
Weight	385 g
Vibration	IEC 60068-2-6 (sinusoidal) / IEC 60068-2-64 (broadband noise)
Shock	IEC 60068-2-27 (25 G and 50 G)
Operating system	Windows 10 Enterprise

Electrical specifications

Voltage supply	8-48 V DC or Power over Ethernet (PoE/ 1000BASE-T)
Power consumption	7.5 W (+ additional 2.5 W for PI camera)
Cooling	Active via two integrated fans
Module	COM Express® mini embedded board
Processor	Intel Atom® E3940 Quad Core 1.6 / 1.8 GHz (Turbo)
Hard drive	32 GB SSD
RAM	4 GB (DDR2, 533 MHz)
Connections	2x USB 2.0, 1x USB 3.0, 1x Mini-USB 2.0, Micro-HDMI, Ethernet (Gigabit Ethernet)
Memory card slots	Micro SDHC/ SDXC card
Additional features	4x Status-LEDs

Stand-alone solution with GigE remote access

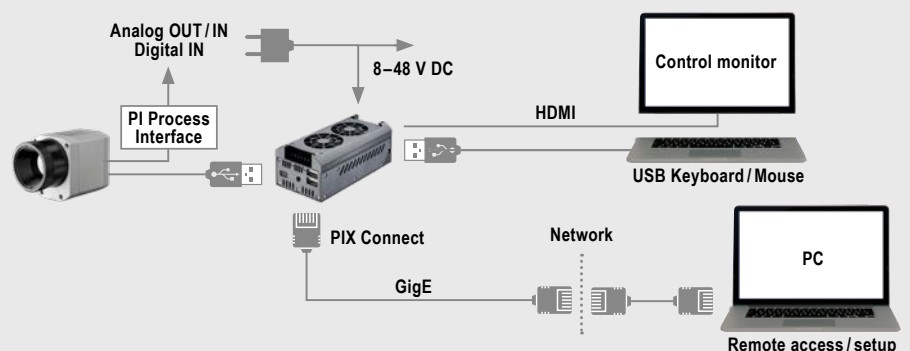

SIMPLE CABLE EXTENSION

Simple cable extension for the optris PI series and Xi 400

- Fully compatible with USB 2.0, Data transfer rate 1.5 / 12 / 480 Mbps, USB transfer mode: isochronous
- Network connection via Gigabit Ethernet
- For all models in the optris **PI series and the Xi 400**
- Full TCP/IP support incl. routing and DNS
- Two independent USB connections
- Power via PoE or external voltage supply at 24 – 48 V DC
- Galvanic isolation 500 VRMS (network connection)
- Remote configuration via web-based management
- Certified technology from Wiesemann & Theis



Technical data

USB connections	2 x USB A Port
USB speed	480 Mbps
Network	10/100/1000 BaseT (max. 1000 Mbps)
Power supply	Power over Ethernet (PoE) class 3 (6,49 – 12,95 W) or via screw terminal DC 24 V ... 48 V (+/-10 %)
Power consumption	External power supply (24 V DC) without USB devices: typ. 120 mA External power supply (24 V DC) with 2 USB devices each 2.5 W: typ. 420 mA
Ambient temperature	Storage: -40 ... 85 °C In operation, individually assembled: 0 ... 50 °C
Permissible relative humidity	0 – 95 % (non-condensing)
Housing	Compact plastic casing for DIN rail mount, 105 x 75 x 22 mm
Weight	200 g
Scope of supply	<ul style="list-style-type: none"> • 1x USB server Gigabit 2.0 • 24 V DC wall plug transformer • Ethernet cable (1m) • Quick start guide* *included on USB-Stick – Software PIX Connect resp. CompactConnect – USB-Redirector – WuTility Management Tool – Manual (DE / EN)

Protocols

USB protocols	USB 1.0 / 1.1 / 2.0 Control / Bulk / Interrupt / Isochronous
Protocols for direct network connection	TCP/IP: Socket Auxiliary protocols: ARP, DHCP, HTTP, PING Inventory keeping, group management

Connection options

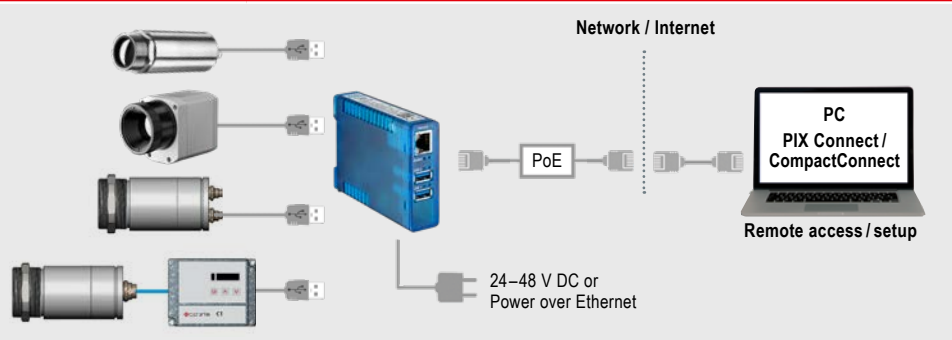

optris Outdoor Protective Housing

UNIVERSAL PROTECTIVE HOUSING FOR IR CAMERAS

Universal outdoor protection for infrared cameras of the optris PI and Xi series

- Environmental rating IP 66
- Additional air purge collar allows for a continuous operation in dusty and humid conditions
- Heating element and built-in fan enable for a 24/7 operation from -40 °C to 50 °C
- Optional Installation of USB Server Gigabit for integration into control systems over large outdoor distances



Specifications

Environmental rating	IP 66
Ambient temperature	-40 ... 50 °C
Heating	PTC heater (automatically starting at T < 15 °C) / fan for homogeneous temperature distribution
Power supply	24 V DC
Power	70 W
Protective window	Germanium (Ge), zinc sulfide (ZnS), Borofloat or foil
Air purge collar	Integrated
Air pressure	Absolute pressure 1,1 - 8 bar at 20 -100 l/min
Max. FOV	90° (HFOV)
Integrated additional components	USB-Server Gigabit 2.0 Industrial Process interface (PIF)
Material	Aluminum
Weight	2 kg (with wall mount 2,5 kg)
Accessories	Optional wall mount bracket

Example of fail-safe monitoring of the PI camera with connected PLC

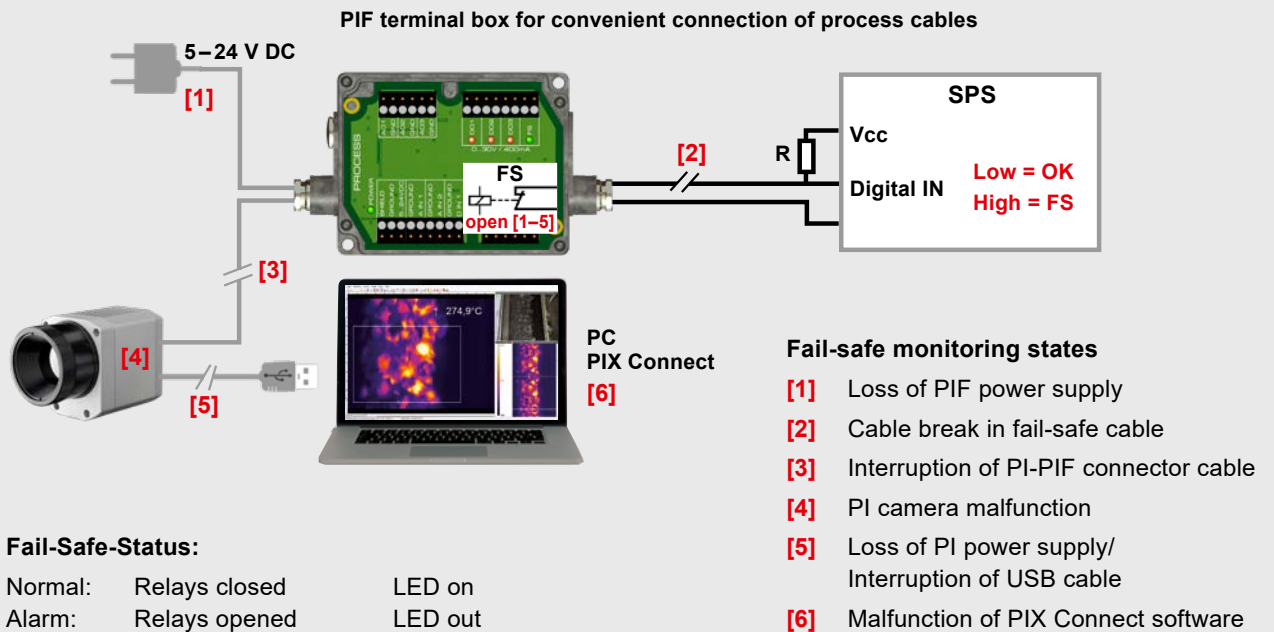



Tool for all optris infrared cameras



- The cameras of the PI series have a direct connection to an android smartphone or tablet
- IRmobile App downloadable for free from the Google Play Store
- For connection to the device the IR App Connector is recommended

Xi 80: Artikel-Nr.: ACXI80IACM (Micro-USB) or ACXI80IACC (USB-C)

Xi 400: Artikel-Nr.: ACPIIACM (Micro-USB) or ACPIIACC (USB-C)

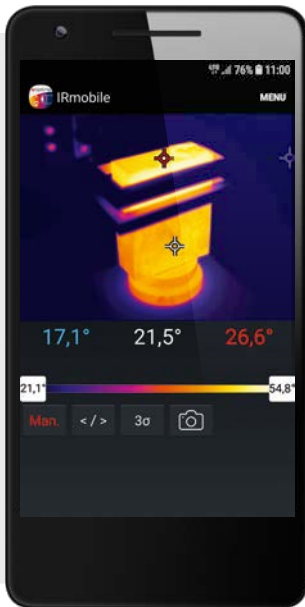

IRmobile app features:

- Live IR image with automatic hot and cold spot
- Adjustable camera features like temperature measuring range, frame rate and selectable color palettes
- Changing the temperature unit: Celsius or Fahrenheit
- Creating snapshots
- Integrated simulator

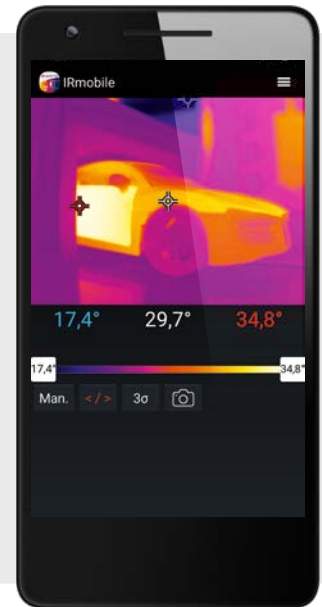

Supported for

- PI and Xi series and all pyrometers
- For android devices from version 5.0 or higher with micro-USB or USB-C connectors that support USB OTG

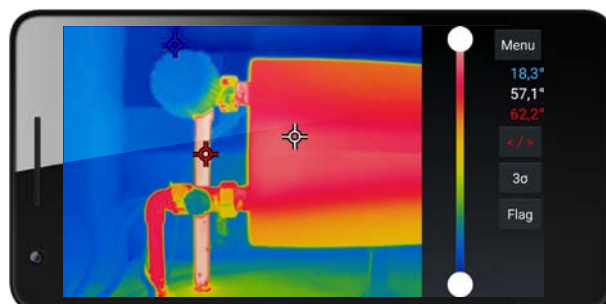

Comprehensive IR camera software

- No additional costs or licensing restrictions
- Modern software with intuitive user interface
- Remote control of camera
- Display of numerous images in different windows
- Compatible with Windows 7, 8 and 10
- Two Software Development Kits for Windows and Linux included
- Various language options, incl. translation function
- Temperature display in °C or in °F

Temperature information in main window, as digital display or as graphic

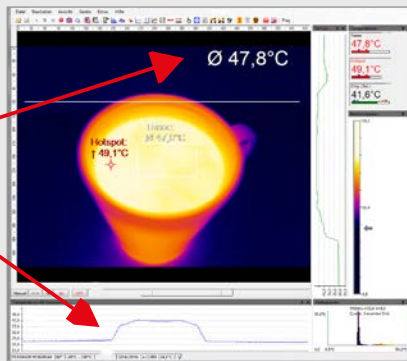

Our layouts – as individual as your applications

Pre-defined layouts make it quick and easy to start with your applications. And because we know that every measurement task has its own individual requirements, we have ensured that it is quite easy to adapt the preset layout to suit your individual requirements.

The user interface of the PIX Connect software can also be adapted to suit your personal workflow: Software windows can be easily arranged using drag & drop; in the toolbar you can save shortcuts for functions relevant to your application – or even remove links which you do not need.

Regardless of whether you are working on a desktop PC or a tablet, the user interface can be adapted.

The PIX Connect software makes a wide range of preset color palettes available. This allows optimal depiction of thermal contrasts. The pre-defined color palettes can be individually adapted to be able to cater for the specific requirements of your respective application.

Associated temperature groups (isotherms) can be identified by color markers and highlighted.

It is also possible to define temperature values in advance; pixels above, below, or between these values are highlighted in color.

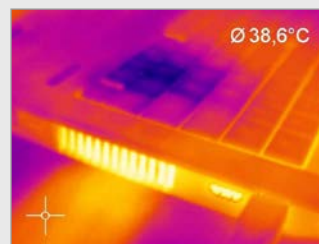

Palette Iron

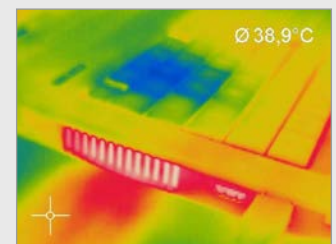

Palette Rainbow

The right color palette for every application



Palette Blue Hi

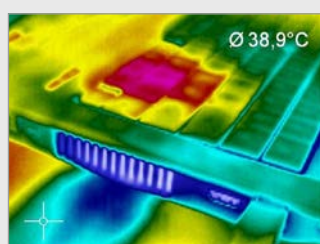

Palette Rainbow Hi

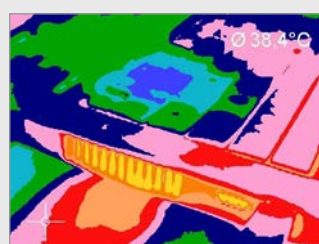

Palette Rainbow Medical



Palette Gray (Black = Cold)

Measuring areas

**It is not just a matter of size, but also depends on the content:
designing a suitable measurement area**

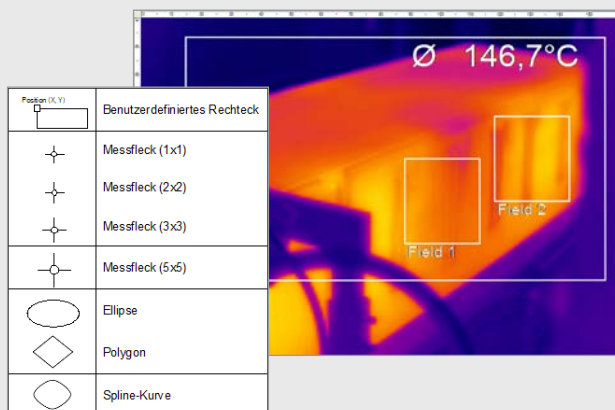

The size and shape of measurement area can be freely designed and moved. For an easy introduction, a large selection of pre-defined measurement area shapes is available.

You can set up as many measurement areas as you like in the camera's field of view. To do this, it is possible to make a distinction between main and ancillary fields.

Various modes can be set in a measurement area, such as minimum value, maximum value, or average value, or you can rule out the detection of hot or cold spots.

The separate setting of the emissivity for measurement areas allows various material surfaces to be monitored with a single camera.

Differences and averaging between different measurement areas are easy to calculate with the PIX Connect software.

Saved measurement areas can be displayed as an image, a digital display or a diagram and can then be saved for further analysis.

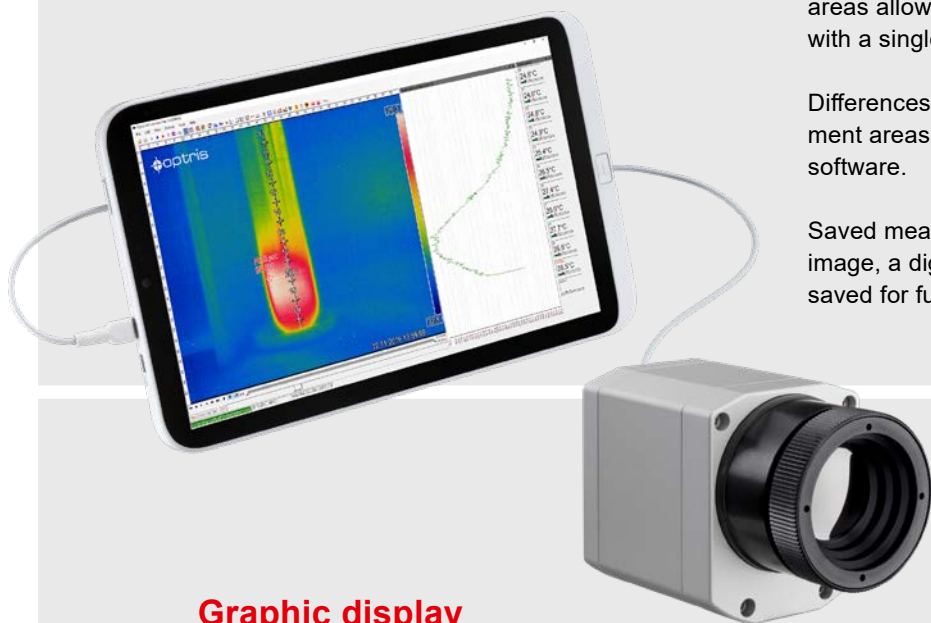

Graphic display of the temperature values

Temperature values can be shown along a straight line as temperature profiles as well as as 3D diagrams.

A temperature/time diagram can be used to analyze the temperature development over time. Individual time sections can be lifted out of the diagram and be analyzed in detail by zooming in and out.

Diagrams defined in this way can be exported from the software and be saved in Excel for further analysis.

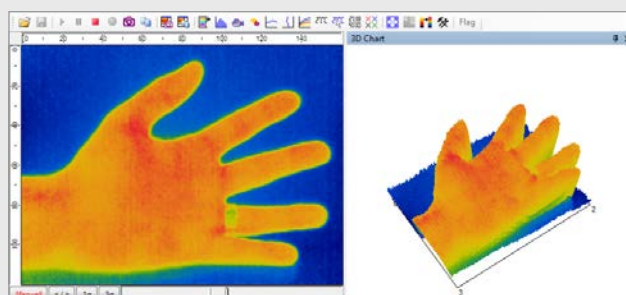
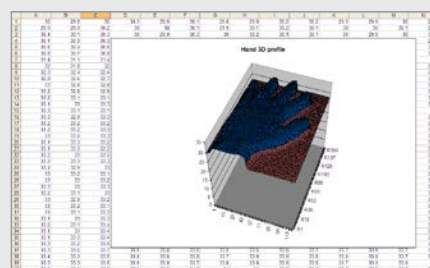

Recording and display

Recording video sequences – for later analysis and documentation

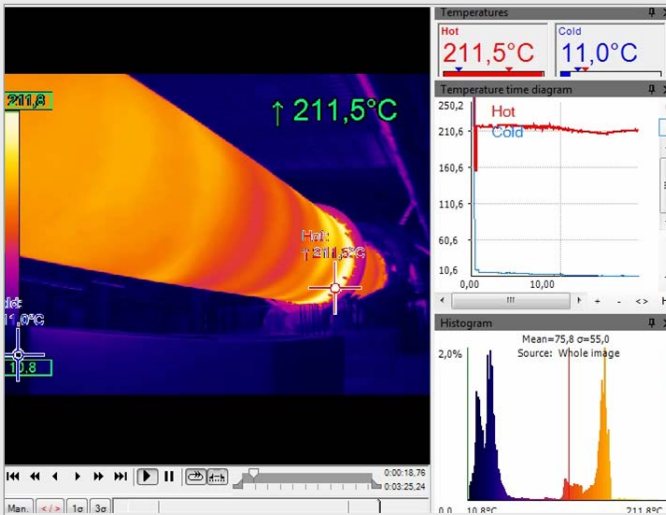

The software can be used to save the recording from the thermal imaging camera as video sequences which can then be saved for analysis later on. The video sequence is recorded for every pixel including all temperature information. An integrated screen capture function makes it simple to retrospectively generate videos in wmv format.

Videos recorded can be processed retrospectively. For example, individual sections can be cut out of a recording and can be saved as an independent sequence.

Saved video recordings are available for analysis. The sequences can be played back in slow motion or time lapse for this purpose. It is also possible to play back as a continuous loop.

Event grabber

The snapshot option works like a screenshot; an individual image is recorded from the live picture. This snapshot is a radiometric image (*.tiff), where all the temperature and measurement area information at the time of the recording is saved for every pixel.

Saving and exporting the image for further analysis in Excel is possible thanks to the option of saving the temperature matrix in text format, e.g. as comma-separated values (.csv format). It is also possible to continue processing the image data with standard programs such as Photoshop or Windows Media Player.

Sections of the saved image can be zoomed in to get a closer look. 3D display is also possible.

Snapshots – all temperature information in one picture

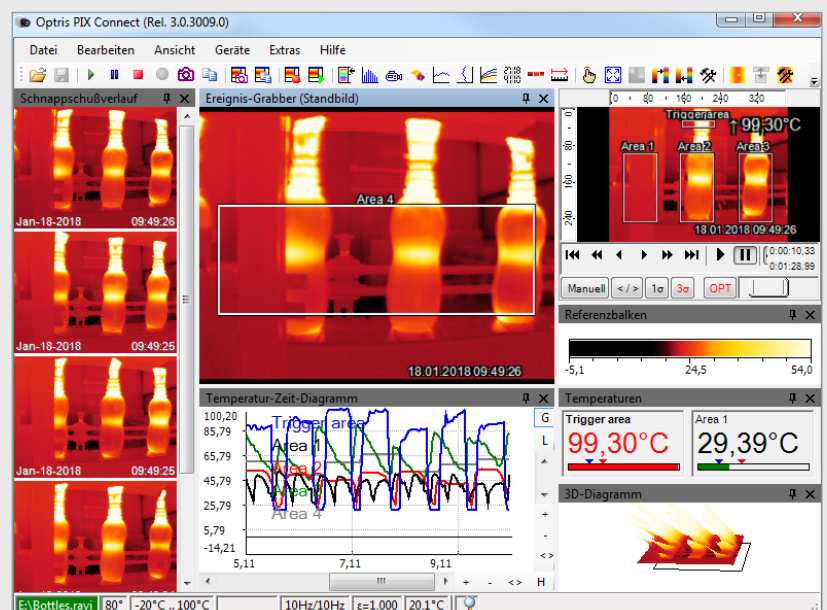

Merging

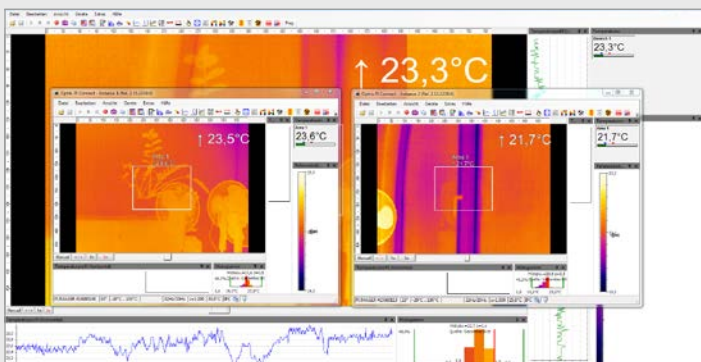

The fields of vision of three cameras (top) are converted into one single image via the merging function. (bottom)



The merging function combines several camera angles together in a single picture

The PIX Connect software gives you the option of grouping together several cameras within a software instance, i.e. the field of view of several infrared cameras are merged together to make a single picture. For processes with several control points in particular, it is helpful to concentrate the various angles on one screen. Merging several cameras also makes it possible to get an all-round view of a 3D object.

You can merge several cameras either using a direct USB connection or via Ethernet. While in the first case, every camera needs to have its own USB port; for the second option, one Ethernet connection is enough. The cameras here are each connected to the Ethernet switch on the PC via a USB Server Gigabit 2.0.

Alarms

Defining several alarm values – allows quick intervention

Temperature dependend alarms for freely definable measurement areas as well as the internal temperature of the camera can be chosen via the software. Apart from minimum and maximum values, it is also possible to set so-called advance alarms. These will emit a warning when the measured temperature approaches the defined minimum or maximum value, therefore giving you more options and time to react.

If the measured temperature reaches one of these previously defined values, then the software will trigger an alarm. In addition to that, the critical event can be easily documented as a snapshot or video recording and be used for analysis later on.

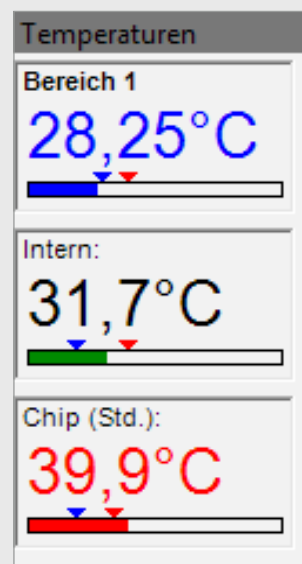

optris PIX Connect

FEATURES

For the measurement of moving objects

The optris PIX Connect software is equipped with a **line scan camera function**.

The line scanner is primarily used for processes involving moving measurement objects, like **rotary kiln measurements** or large quantities on conveyor belts (**batch process**).



The advantages

Simple monitoring of processes with limited visual access

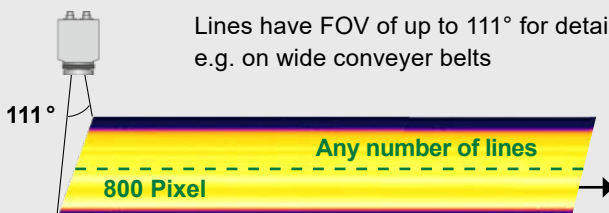
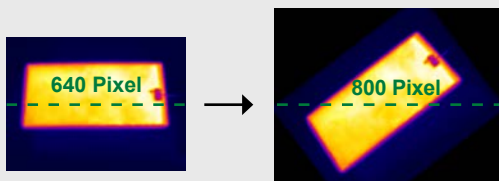
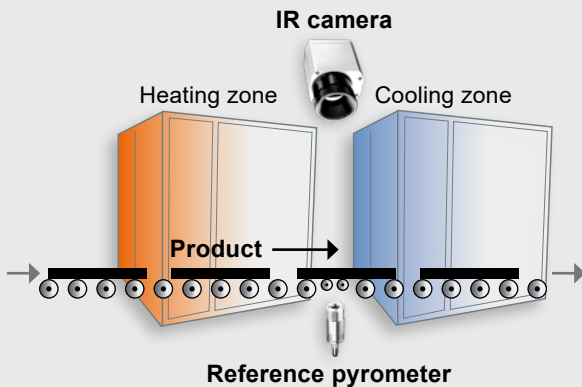

Up to 32 Hz data recording* of unlimited lines which in turn produce a thermal image of any given resolution.

*Up to 125 Hz data recording when using 90° in subframe mode (640 x 120px)

Only 3 steps to initialize the function

Step 1

Activation of the line scan camera function (continuous, self-triggered, external trigger) and definition of the position of the lines in the thermal image. For this the camera itself serves as an orientation aid.

Step 2

Configuration of line scan function, e.g. number of lines displayed or set trigger for automatic saving of images.

Step 3

Definition of individual layouts, e.g. display of saved images in the snapshot process.

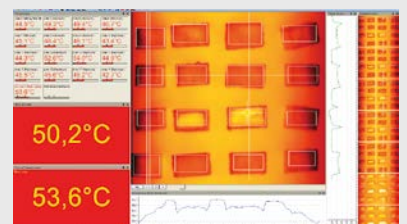

Layout example for display of line scan camera function

For further information and hands-on tutorials regarding our software PIX Connect available



on our  **YouTube** – Channel

or visit our website:

www.optris.global/software-tutorials

Precise measuring at various distances

A choice of lenses allows you to precisely measure objects at various distances, from close and standard distances right up to large distances. The IR cameras of the optris PI series allow for changing between several lenses.

With infrared cameras there are various parameters which display the relationship between the distance from the measuring object and the size of the pixel on the object plane. In choosing the correct lens, the following should be taken into account:

- HFOV** Horizontal expansion of the total measuring field on the object plane
- VFOV** Vertical expansion of the total measuring field on the object plane
- IFOV** Size of individual pixels on the object plane
- DFOV** Diagonal expansion of the total measuring field on the object plane
- MFOV** Recommended, smallest measuring object size of 3 x 3 pixels or 2 x 2 pixels when using the PI microscope optics or the Xi 80, respectively

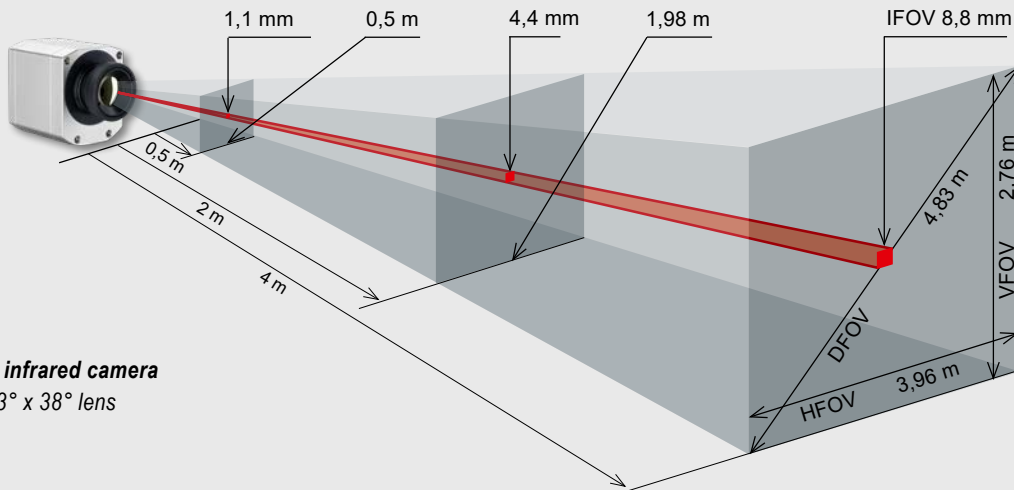

Measuring field of the infrared camera
optris PI 450i using a 53° x 38° lens

Optris calculator



- Combines the measuring spot size calculator of the IR pyrometers and the optics calculator of the IR cameras
- The measuring spot size of the respective device is calculated for each distance

IR cameras

- Based on camera/lens combination and the distance to the object, the measuring field dimensions and pixel size are calculated precisely.
- Ensures an optimal positioning of the camera and the avoidance of measuring errors

Features

- Calculates for each distance the measuring spot size of the respective device
- Always the current features through regular updates



Pyrometer

- The spot size calculator determines the exact spot size for all sensor/optics combinations for any entered distance
- For reliable measurements

Supported for

- All android devices from version 5.0 or higher



Optical data

OPTICS

Xi 80		Focal length [mm]	Minimum measurement distance*	Angle	Distance to measurement object [m]											
80 x 80 px					0.05	0.1	0.2	0.3	0.5	1	2	4	6	10	30	100
F05 Standard lens	5				0,2 m	30° 6.67 mrad	HFOV [m]	0.028	0.056	0.111	0.167	0.279	0.557	1.115	2.230	3.346
		VFOV [m]	0.028	0.056			0.111	0.167	0.279	0.557	1.115	2.230	3.346	5.6	16.7	55.8
		DFOV [m]	0.039	0.079			0.158	0.24	0.39	0.79	1.58	3.15	4.7	7.9	23.7	78.9
		IFOV [mm]	0.33	0.67			1.33	2.0	3.33	6.67	13.33	26.67	40.00	66.67	200.00	666.67
F13 Telephoto lens	13	0,3 m	12° 2.66 mrad	HFOV [m]		0.022	0.043	0.065	0.11	0.21	0.43	0.85	1.28	2.1	6.4	21.3
				VFOV [m]		0.022	0.043	0.065	0.11	0.21	0.43	0.85	1.28	2.1	6.4	21.3
				DFOV [m]		0.031	0.061	0.092	0.15	0.30	0.60	1.20	1.81	3.0	9.0	30.1
				IFOV [mm]		0.3	0.5	0.8	1.3	2.7	5.3	10.6	15.9	26.6	79.7	265.6
F03 Wide angle lens	3	0,2 m	55° 11.15 mrad	HFOV [m]	0.057	0.110	0.218	0.325	0.539	1.07	2.14	4.27	6.41	10.7	32.0	106.7
				VFOV [m]	0.057	0.110	0.218	0.325	0.539	1.07	2.14	4.27	6.41	10.7	32.0	106.7
				DFOV [m]	0.080	0.156	0.308	0.459	0.762	1.52	3.02	6.04	9.06	15.1	45.3	150.9
				IFOV [mm]	0.6	1.2	2.3	3.4	5.6	11.2	22.4	44.6	66.9	111.5	334.5	1114.8
F02 Super wide angle lens	2	0,2 m	80° 15.45 mrad	HFOV [m]	0.090	0.174	0.343	0.509	0.884	1.682	3.357	6.708	10.058	16.8	50.3	167.5
				VFOV [m]	0.090	0.174	0.343	0.509	0.88	1.682	3.357	6.708	10.058	16.8	50.3	167.5
				DFOV [m]	0.127	0.246	0.483	0.72	1.19	2.38	4.75	9.49	14.2	23.7	71.1	236.9
				IFOV [mm]	0.08	1.6	3.2	4.7	7.8	15.5	31.0	61.9	92.8	154.6	463.7	1545.5

Xi 400		Focal length [mm]	Minimum measurement distance*	Angle	Distance to measurement object [m]											
382 x 288 px					0.05	0.1	0.2	0.3	0.5	1	2	4	6	10	30	100
F12 Standard lens	13				0.35 m	29° 1.3 mrad	HFOV [m]		0.055	0.111	0.16	0.27	0.52	1.04	2.1	3.1
		VFOV [m]		0.042			0.081	0.12	0.20	0.39	0.78	1.6	2.3	3.9	11.7	38.9
		DFOV [m]		0.069			0.137	0.20	0.33	0.66	1.30	2.6	3.9	6.5	19.4	64.7
		IFOV [mm]		0.1			0.3	0.4	0.7	1.3	2.7	5.4	8.0	13.4	40.2	133.9
F20 Telephoto lens	20	0.35 m	18° 0.9 mrad	HFOV [m]			0.067	0.099	0.16	0.32	0.65	1.29	1.9	3.2	9.7	32.2
				VFOV [m]			0.051	0.076	0.12	0.25	0.49	0.98	1.5	2.5	7.4	24.6
				DFOV [m]			0.084	0.125	0.21	0.41	0.81	1.62	2.4	4.1	12.2	40.5
				IFOV [mm]			0.2	0.3	0.4	0.9	1.7	3.4	5.1	8.5	25.6	85.4
F08 Wide angle lens	8	0.25 m	53° 2.2 mrad	HFOV [m]		0.105	0.20	0.30	0.50	1.00	2.00	4.00	6.0	10.0	29.9	99.7
				VFOV [m]		0.073	0.14	0.21	0.35	0.70	1.4	2.8	4.1	6.9	20.7	68.9
				DFOV [m]		0.128	0.25	0.37	0.62	1.22	2.4	4.9	7.30	12.1	36.4	121.2
				IFOV [mm]		0.22	0.4	0.7	1.1	2.2	4.4	8.8	13.2	22.0	65.9	219.6
F06 Super wide angle lens	6	0.2 m	80° 3.0 mrad	HFOV [m]	0.085	0.16	0.32	0.48	0.82	1.7	3.4	6.7	10.1	16.8	50.4	167.8
				VFOV [m]	0.055	0.10	0.20	0.30	0.51	1.0	2.0	4.1	6.1	10.2	30.6	101.9
				DFOV [m]	0.101	0.19	0.38	0.57	0.97	1.9	3.9	7.9	11.8	19.7	58.9	196.4
				IFOV [mm]	0.2	0.3	0.6	0.9	1.5	3.0	6.0	12.0	18.1	30.1	90.3	301.2

Table with examples showing which measurement field sizes and pixel sizes will be reached at which distance. For optimal configuration of the camera there are various lenses available. Wide angle lenses have radial distortion due to the angle of their aperture. The PIX Connect software has an algorithm which corrects this distortion.

*Please note: Please use the optics calculator on our website in order to calculate measurement fields with shorter measurement distances:

www.optris.global/optics-calculator

The measurement accuracy of the camera may lie outside of the specifications for distances below the defined minimum measurement distance.

PI 400i / 450i PI 450i G7	Brennweite [mm]	Minimaler Messabstand*	Winkel	Entfernung zum Messobjekt [m]												
					0,05	0,1	0,2	0,3	0,5	1	2	4	6	10	30	100
O29 Standard lens	13	0,35 m	29°	HFOV [m]		0,057	0,111	0,16	0,27	0,53	1,06	2,1	3,2	5,3	15,7	52,5
			22°	VFOV [m]		0,042	0,081	0,12	0,20	0,40	0,80	1,6	2,4	4,0	11,9	39,6
			37°	DFOV [m]		0,071	0,137	0,20	0,34	0,67	1,32	2,6	4,0	6,6	19,7	65,7
			1,3 mrad	IFOV [mm]		0,1	0,3	0,4	0,7	1,3	2,7	5,4	8,0	13,4	40,2	133,9
O18 Telephoto lens	20	0,45 m	18°	HFOV [m]			0,066	0,099	0,16	0,33	0,65	1,3	1,9	3,2	9,7	32,4
			14°	VFOV [m]			0,050	0,075	0,12	0,25	0,49	1,0	1,5	2,5	7,4	24,6
			23°	DFOV [m]			0,083	0,124	0,20	0,41	0,82	1,6	2,4	4,1	12,2	40,7
			0,9 mrad	IFOV [mm]			0,2	0,3	0,4	0,9	1,7	3,5	5,2	8,6	25,9	86,3
O53 Wide angle lens	8	0,25 m	53°	HFOV [m]		0,103	0,20	0,30	0,50	1,0	2,0	4,0	5,9	9,9	29,6	98,6
			38°	VFOV [m]		0,073	0,14	0,21	0,35	0,70	1,4	2,8	4,1	6,9	20,7	68,9
			66°	DFOV [m]		0,127	0,25	0,37	0,61	1,22	2,4	4,8	7,2	12,0	36,1	120,3
			2,2 mrad	IFOV [mm]		0,2	0,4	0,7	1,1	2,2	4,4	8,8	13,2	21,9	65,8	219,4
O80 Super wide angle lens	6	0,2 m	80°	HFOV [m]	0,087	0,17	0,33	0,49	0,82	1,7	3,3	6,7	10,0	16,6	49,9	166,4
			54°	VFOV [m]	0,056	0,11	0,21	0,31	0,51	1,0	2,0	4,1	6,1	10,2	30,6	101,9
			96°	DFOV [m]	0,103	0,20	0,39	0,58	0,97	2,0	3,9	7,8	11,7	19,5	58,5	195,1
			3,0 mrad	IFOV [mm]	0,2	0,3	0,6	0,9	1,5	3,0	6,0	12,0	18,1	30,1	90,3	300,9

PI 640 / PI 640 G 7	Brennweite [mm]	Minimaler Messabstand*	Winkel	Entfernung zum Messobjekt [m]												
					0,1	0,2	0,3	0,5	1	2	4	6	10	30	100	
O33 Standardoptik	18,7	0,2 m	33°	HFOV [m]	0,068	0,13	0,19	0,31	0,60	1,20	2,38	3,57	5,9	17,8	59,3	
			25°	VFOV [m]	0,051	0,09	0,14	0,23	0,45	0,89	1,77	2,65	4,4	13,2	44,2	
			41°	DFOV [m]	0,085	0,16	0,23	0,38	0,75	1,49	2,97	4,45	7,4	22,2	74,0	
			0,91 mrad	IFOV [mm]	0,1	0,2	0,3	0,5	0,9	1,8	3,6	5,5	9,1	27,3	90,9	
O15 Teleoptik	41,5	0,5 m	15°	HFOV [m]				0,13	0,26	0,52	1,05	1,57	2,6	7,8	26,1	
			11°	VFOV [m]				0,10	0,20	0,39	0,79	1,18	2,0	5,9	19,6	
			19°	DFOV [m]				0,17	0,33	0,66	1,31	1,96	3,3	9,8	32,7	
			0,41 mrad	IFOV [mm]				0,2	0,4	0,8	1,6	2,5	4,1	12,3	41,0	
O60 Weitwinkeloptik	10,5	0,2 m	60°	HFOV [m]	0,128	0,25	0,36	0,59	1,17	2,32	4,63	6,94	11,6	34,6	115,4	
			45°	VFOV [m]	0,091	0,18	0,26	0,42	0,83	1,66	3,31	4,96	8,3	24,7	82,4	
			75°	DFOV [m]	0,157	0,30	0,44	0,72	1,43	2,85	5,69	8,52	14,2	42,6	141,8	
			1,62 mrad	IFOV [mm]	0,2	0,3	0,5	0,8	1,6	3,2	6,5	9,7	16,2	48,6	161,9	
O90 Superweitwinkel- optik	7,7	0,2 m	90°	HFOV [m]	0,220	0,43	0,63	1,03	2,03	4,04	8,06	12,07	20,1	60,3	200,8	
			64°	VFOV [m]	0,138	0,27	0,39	0,64	1,27	2,53	5,05	7,57	12,6	37,8	125,9	
			111°	DFOV [m]	0,260	0,50	0,73	1,21	2,39	4,76	9,50	14,24	23,7	71,1	237,0	
			2,21 mrad	IFOV [mm]	0,2	0,4	0,7	1,1	2,2	4,4	8,8	13,2	22,1	66,2	220,8	

Optical data

OPTICS

PI 1M / PI 08M ¹⁾ / PI 05M ¹⁾	Focal length [mm]	Minimum measurement distance*	Angle	Distance to measurement object [m]											
					0.1	0.2	0.3	0.5	1	2	4	6	10	30	100
382 x 288 px	16	0.2 m	20°	HFOV [m]		0.07	0.11	0.18	0.36	0.72	1.43	2.15	3.6	10.7	35.8
			15°	VFOV [m]		0.05	0.08	0.14	0.27	0.54	1.08	1.62	2.7	8.1	27.0
			25°	DFOV [m]		0.09	0.13	0.22	0.45	0.90	1.79	2.69	4.5	13.5	44.9
			0.94 mrad	I FOV [mm]		0.2	0.3	0.5	0.9	1.9	3.8	5.6	9.4	28.1	93.8
OF25	25	0.5 m	13°	HFOV [m]	0.023	0.05	0.07	0.11	0.23	0.46	0.92	1.38	2.3	6.9	22.9
			10°	VFOV [m]	0.017	0.03	0.05	0.09	0.17	0.35	0.69	1.04	1.7	5.2	17.3
			16°	DFOV [m]	0.029	0.06	0.09	0.14	0.29	0.57	1.15	1.72	2.9	8.6	28.7
			0.60 mrad	I FOV [mm]	0.1	0.1	0.2	0.3	0.6	1.2	2.4	3.6	6.0	18.0	60.0
OF50	50	1.5 m	7°	HFOV [m]				0.06	0.11	0.23	0.46	0.69	1.1	3.4	11.5
			5°	VFOV [m]				0.04	0.09	0.17	0.35	0.52	0.9	2.6	8.6
			8°	DFOV [m]				0.07	0.14	0.29	0.57	0.86	1.4	4.3	14.4
			0.30 mrad	I FOV [mm]				0.2	0.3	0.6	1.2	1.8	3.0	9.0	30.0
OF75	75	2.0 m	4°	HFOV [m]					0.08	0.15	0.31	0.46	0.8	2.3	7.6
			3°	VFOV [m]					0.06	0.12	0.23	0.35	0.6	1.7	5.8
			5°	DFOV [m]					0.10	0.19	0.38	0.57	1.0	2.9	9.6
			0.20 mrad	I FOV [mm]					0.2	0.4	0.8	1.2	2.0	6.0	20.0

Table with examples showing which measurement field sizes and pixel sizes will be reached at which distance. For optimal configuration of the camera there are various lenses available. Wide angle lenses have radial distortion due to the angle of their aperture. The PIX Connect software has an algorithm which corrects this distortion.

*Please note: Please use the optics calculator on our website in order to calculate measurement fields with shorter measurement distances:

www.optris.global/optics-calculator

The measurement accuracy of the camera may lie outside of the specifications for distances below the defined minimum measurement distance.

¹⁾The optris PI 05M is only available with OF25 lens and the optris PI 08M is available with OF16 and OF25 lenses.

PI 1M / PI 08M ¹⁾ / PI 05M ¹⁾	Focal length [mm]	Minimum measurement distance*	Angle	Distance to measurement object [m]											
					0.1	0.2	0.3	0.5	1	2	4	6	10	30	100
764 x 480 px	16	0.2 m	39°	HFOV [m]		0.14	0.21	0.36	0.72	1.43	2.87	4.30	7.2	21.5	71.6
			25°	VFOV [m]		0.09	0.14	0.23	0.45	0.90	1.80	2.70	4.5	13.5	45.0
			46°	DFOV [m]		0.17	0.25	0.42	0.85	1.69	3.38	5.08	8.5	25.4	84.6
			0.94 mrad	I FOV [mm]		0.2	0.3	0.5	0.9	1.9	3.8	5.6	9.4	28.1	93.8
OF25	25	0.5 m	26°	HFOV [m]	0.046	0.09	0.14	0.23	0.46	0.92	1.83	2.75	4.6	13.8	45.8
			16°	VFOV [m]	0.029	0.06	0.09	0.14	0.29	0.58	1.15	1.73	2.9	8.6	28.8
			30°	DFOV [m]	0.054	0.11	0.16	0.27	0.54	1.08	2.17	3.25	5.4	16.2	54.1
			0.60 mrad	I FOV [mm]	0.1	0.1	0.2	0.3	0.6	1.2	2.4	3.6	6.0	18.0	60.0
OF50	50	1.5 m	13°	HFOV [m]				0.11	0.23	0.46	0.92	1.38	2.3	6.9	22.9
			8°	VFOV [m]				0.07	0.14	0.29	0.58	0.86	1.4	4.3	14.4
			15°	DFOV [m]				0.14	0.27	0.54	1.08	1.62	2.7	8.1	27.1
			0.30 mrad	I FOV [mm]				0.2	0.3	0.6	1.2	1.8	3.0	9.0	30.0
OF75	75	2.0 m	9°	HFOV [m]					0.15	0.31	0.61	0.92	1.5	4.6	15.3
			5°	VFOV [m]					0.10	0.19	0.38	0.58	1.0	2.9	9.6
			10°	DFOV [m]					0.18	0.36	0.72	1.08	1.8	5.4	18.0
			0.20 mrad	I FOV [mm]					0.2	0.4	0.8	1.2	2.0	6.0	20.0

¹⁾The optris PI 05M is only available with OF25 lens and the optris PI 08M is available with OF16 and OF25 lenses.

Microscope optics PI 640 640 x 480 px	Focal length [mm]	Minimum measurement distance*	Angle	Distance to measurement object [m]			
					0.08	0.09	0.1
MO44 Microscope optics	44.2	0.08 m	12°	HFOV [m]	0.018	0.021	0.023
			9°	VFOV [m]	0.014	0.016	0.017
			15°	DFOV [m]	0.023	0.026	0.029
			0.36 mrad	IFOV [mm]	0.028	0.032	0.036

Microscope optics Xi 400 382 x 288 px	Focal length [mm]	Minimum measurement distance*	Angle	Distance to measurement object [m]			
					0.09	0.1	0.11
F20 CF Microscope optics	20	0.09 m	18°	HFOV [m]	0.031	0.034	0.037
			14°	VFOV [m]	0.024	0.026	0.028
			23°	DFOV [m]	0.039	0.043	0.047
			0.9 mrad	IFOV [mm]	0.08	0.09	0.10

APPLICATIONS

Injection molding

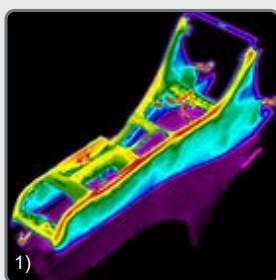

In order to prevent component distortion during injection molding, the process is monitored by thermal imaging cameras detecting and adjusting temperature over- or undershoots during molded part measurement.

Recommended device: PI 450i

Infrared technology for fire protection

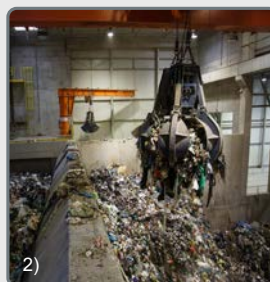

Early fire detection with infrared cameras is an important protective measure in industry to prevent irreparable damage to industrial plants and buildings.

Recommended device:
Xi 400

Component inspection of circuit boards

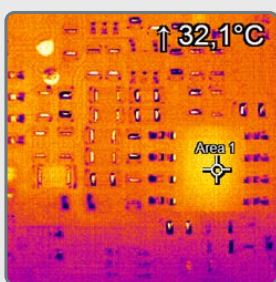

More and more manufacturers of electronic circuit boards rely on non-contact temperature measurement due to the constantly increasing performance of their components.

Recommended devices:
PI 640 microscope optics,
Xi 400 microscope optics

Workpiece control during drop forging

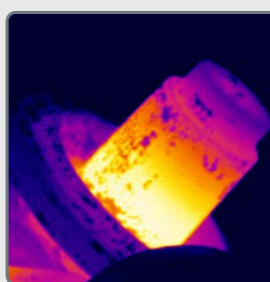

In drop forging, the semi-finished products must be at a certain forging temperature before forming. In order to achieve the optimum production result, the surface temperature of the material is controlled accordingly.

Recommended devices:
PI 1M, PI 05M

when temperature matters

Optris GmbH
Ferdinand-Buisson-Str. 14
13127 Berlin · Germany
Tel.: +49 30 500 197-0
Fax: +49 30 500 197-10

E-Mail: info@optris.global
www.optris.global